

**STRUCTURAL ASSESSMENT AND PROPOSALS FOR REPAIR,  
CONSERVATION AND PRIORITIZATION OF URGENT  
WORKS  
FOR  
FIFTEEN ARCHAEOLOGICAL MONUMENTS  
IN  
FINGAL COUNTY COUNCIL OWNERSHIP**

**Dermot Nolan & Associates  
Historic Buildings Consultants  
& Consulting Engineers  
'Claremount'  
Meath Road  
Bray  
Co. Wicklow  
Tel: 01-276 2626  
Email: [dnolanconservation@eircom.net](mailto:dnolanconservation@eircom.net)**

## CONTENTS

<b>CHAPTER</b>	<b>PAGE</b>
<b>Executive Summary</b>	<b>3</b>
<b>General Introduction</b>	<b>4</b>
<b>Prioratisation Scheme</b>	<b>6</b>
<b>Prioritisation of the works</b>	<b>7</b>
<b>Contract Procedures</b>	<b>9</b>
<b>Site 1 – Garristown Church</b>	<b>11</b>
<b>Site 2 – Grallagh Church</b>	<b>25</b>
<b>Site 3 – Stella’s Tower, Portrane</b>	<b>36</b>
<b>Site 4 – Lanestown Castle, Donabate</b>	<b>50</b>
<b>Site 5 – Church at Malahide Demesne</b>	<b>64</b>
<b>Site 6 – Saint Marnock’s Church, Portmarnock</b>	<b>79</b>
<b>Site 7 – Church at Saint Catherine’s Park, Leixlip</b>	<b>92</b>
<b>Site 8 – Martello Tower, Balbriggan</b>	<b>103</b>
<b>Site 9 – Martello Tower, Skerries</b>	<b>114</b>
<b>Site 10 – Church Tower, Holmpatrick, Skerries</b>	<b>128</b>
<b>Site 11 - Castle at Rush Demesne, Rush</b>	<b>140</b>
<b>Site 12 – Church at Rush Demesne, Rush</b>	<b>152</b>
<b>Site 13 – Knocksedan Bridge, Swords</b>	<b>163</b>
<b>Site 14 – Saint Catherine’s Church, Portrane</b>	<b>175</b>
<b>Site 15 – Saint Fintan’s Church, Sutton</b>	<b>188</b>

## **EXECUTIVE SUMMARY**

Site inspections of fifteen diverse monuments in the care of Fingal County Council were undertaken. Each monument was visually assessed, photographed and measured. Individual reports were prepared on each monument which included a description, drawings, and an assessment of present condition and of vulnerability. Each report contains a list of proposed remedial works and identifies the most urgent works.

A prioritization of the proposed works was drawn up based on the assessments of condition and vulnerability. The purpose of the prioritization is to permit decisions to be taken on the appropriate allocation of resources and funding for the maintenance of the monuments.

## **GENERAL INTRODUCTION**

Fingal County Council commissioned the writer to carry out structural assessments of archaeological monuments in the Council's ownership. The purpose of the project is to analyse the structural integrity of the monuments, identify structural defects to make recommendations for appropriate mitigation and repairs and to propose a prioritization of urgent works.

The project involved visiting each site, making a photographic record and preparing measured drawings and a schedule of proposed works. The report contains a prioritization for the works taking into account the severity of the various defects, the cultural significance of the structure and its vulnerability to further decay and damage including damage caused by vandalism.

The subject sites are very diverse and consequently each had to be studied, assessed and reported on in a manner appropriate to its special character. Access to the interiors or higher levels of some structures was not possible and, as a result, some defects may have been overlooked. Many of the structures were concealed by ivy and other vegetation to the extent that construction details could not be recorded with confidence and structural problems may have been hidden. In these cases assumptions have been made based on whatever visible evidence was available and on previous experience of examining similar structures. In all such cases, strong recommendations are made that permanent safe access be provided to permit on-going inspection and maintenance and that vegetation should be carefully removed from the structures.

Archaeological monuments are protected by the provisions of the National Monuments Acts (1930 - 2004). The National Monuments Service of the Department of Arts, Heritage and the Gaeltacht maintains a record of all known archaeological monuments and is responsible for implementing the provisions of the National Monuments Acts. The National Monuments Service maintains a list of the known monuments - the Record of Monuments and Places (RMP) - and each site is allocated a unique identifying number in the Record. When a person intends to carry out any works which might affect a recorded monument or place, they are required to give two month's notice in writing to the Minister before commencing the work. The written consent of the Minister is required before work commences. Works which involve excavation at archaeological sites require an Excavation License which may be obtained from the National Monuments Service. Most of the sites examined in this survey are Recorded Monuments.

Many of the monuments are also listed as Protected Structures. Each Local Authority is required to prepare a list of buildings and other structures of cultural significance which post-date 1600 for inclusion in its



Development Plans. These are referred to as 'Protected Structures'. Special planning conditions are attached to such structures and generally speaking, no development of any kind can be carried out affecting them without first applying for, and receiving, planning permission. Many of the monuments which are the subject of this study are protected structures. Although the subject structures are in the ownership of Fingal County Council it is still necessary to go through a planning process and, in particular to inform the public and specially designated public authorities prior to commencing works.

## **PRIORITISATION SCHEME**

A scale of one to five has been used to describe the present vulnerability of the monuments. The points on the scale are established as follows:

- 1 – No works required at present.
- 2 – Relatively minor works are required to improve the vulnerability to level 1.
- 3 - Extant structural defects (or conditions such as vegetation growth on the monument or vandalism) may damage the integrity and sustainability of the monument in the medium term.
- 4 - Extant structural defects or conditions may damage the integrity and sustainability of the monument in the short term.
- 5 - The integrity of the monument is considered to be under immediate threat due to extant structural defects or conditions.

Medium term is considered to be a period of several years (2-3). Short term is considered to be about one year. Clearly the levels of vulnerability attributed to the various monuments are in many cases established on the basis of assumptions which have to be made in the absence of full access or clear visibility. In cases where access to interiors or upper levels was not possible it is recommended as a priority that such access be made possible.

In the cases of some monuments particular works are identified as having a higher priority than others and it may be assumed that should those particular works be carried out, the level of vulnerability would fall. This applies, for example, to the chimney in Stella's Tower (site number 3)

In the special case of Knocksedan Bridge (site number 13), although there are no obvious major defects, the removal of vegetation followed by a detailed structural assessment is given high priority because of the size of the structure and the possible catastrophic effects of failure.

It is highly recommended that a planned and structured monitoring programme be implemented on a permanent basis. All monuments should be inspected on at least a yearly basis.

## PRIORITISATION OF THE WORKS

The following list is a proposed prioritization of the works on the fifteen monuments. The most urgent works are listed in each case. For a more complete identification and listing of the works required in each case the detailed reports on each site should be consulted.

### VULNERABILITY LEVEL 5

1. **Stella's Tower (site number 3)** – Repair and stabilization of the chimney.
2. **Church at Saint Catherine's Park , Leixlip (site number 7)** – Removal of vegetation and repair of masonry.
3. **Rush Demesne Tower House (site number 11)** – Secure against vandalism, repair cracked lintels, remove vegetation.
4. **Knocksedan Bridge (site number 13)** – Remove vegetation and carry out a detailed structural survey.
5. **Saint Marnock's Church, Portmarnock (site number 6)** – Re-point and stabilize the masonry.
6. **Grallagh Church (site number 2)** – Remove vegetation, re-point and stabilize the masonry.

### VULNERABILITY LEVEL 4

7. **Lanestown Castle (site number 4)** – Investigate and deal with subsidence of the exterior wall.
8. **Saint Catherine's Church Portrane (site number 14)** – Repair the damaged masonry on the inside of the tower walls at former joist seatings.

### VULNERABILITY LEVEL 3

9. **Stella's Tower (site number 3)** – Remove vegetation, provide access to the interior to assess the condition.
10. **Lanestown Castle (site number 4)** – Provide access to the interior to assess the condition. Repair bulged and holed masonry on the exterior walls.

- 11. Martello Tower Skerries (site number 9)** – Provide access to the roof. Install waterproof membrane on the roof.
- 12. Church Tower, Holmpatrick, Skerries (site number 10)** – Provide access to the roof level. Re-point crenellations and re-roof.

#### **VULNERABILITY LEVEL 2-3**

- 13. Garristown Church (site number 1)** – Investigate and deal with the possible subsidence of the tower wall. Repair the wall cracks.
- 14. Church at Rush Demesne (site number 12)** – Investigate and deal with the subsidence of the west gable wall.

#### **VULNERABILITY LEVEL 2**

- 15. Martello Tower Balbriggan (site number 8)** – Provide access to the roof and interior. Install waterproof membrane on the roof if necessary.
- 16. Saint Fintan's Church, Sutton (site number 15)** – Repair the infilling to the east window. Remove the interior vegetation.
- 17. Church at Malahide Demesne (site number 5)** – Repair the stone tracery in the west window.

## **CONTRACT PROCEDURES**

The following Procedures should be followed by Contractors engaged to carry out any remedial, protective or conservation works proposed in this document. The Procedures should be included in all contracts prepared for such works and the ability and experience of tenderers in implementing Procedures of this type should be included as a criterion in awarding contracts.

### **1.0 GENERAL**

- 1.1 All materials used should be compatible with historic construction materials. Portland cement should not be used without specific written authorisation from the consultant. All leadwork shall be Code 5 and shall be carried out in accordance with the recommendations of the LDA (Lead Development Association).
- 1.2 Removal of, or damage to, historic fabric should be minimised.
- 1.3 Replacement of fabric shall use materials salvaged from demolition works as far as possible.
- 1.4 All interventions should be reversible as far as reasonably possible.
- 1.5 All methods and materials used should be fully documented.
- 1.6 No works may commence without prior agreement on a method statement by the contractor and the consultant.
- 1.7 All work shall comply with the relevant legislation and the regulations of the statutory authorities. In particular, the Health and Safety Authority's requirements shall be complied with.
- 1.8 Due regard must be given at all times to the protection of fauna and flora and their habitats and ecological recommendations must be strictly adhered to.

### **2.0 RECORDING**

- 2.1 Interventions should not commence until the existing fabric has been appropriately recorded by photograph, drawing and written description. The appropriate level and method of recording in each case shall be decided by the Conservation Consultant.

2.2 The Contractor shall, as a minimum, make a photographic record prior to commencement, during the course of the work and on completion.

2.3 The Contractor shall record the work and materials used in a diary. When the intervention is complete the Contractor shall provide the Consultant with a written record of the work carried out and the materials used.

### 3.0 **UNEXPECTED CONDITIONS AND HIDDEN FEATURES**

Should unexpected conditions arise or hidden features be exposed in the course of the work, the work must cease and the consultant must be informed immediately.

### 4.0 **METHOD STATEMENT**

4.1 Notwithstanding the fact that many interventions will involve repetition (e.g. making openings in walls), a specific method statement should be produced by the contractor for each intervention.

4.2 The method statement should contain:

4.2.1 A description of the methodology and level of recording which will be used.

4.2.2 Details of the materials and the sources of the materials which will be used in the work.

4.2.3 Details of the temporary works and equipment to be used.

4.2.4 A description of the sequence of operations to be carried out.

4.2.5 A programme for the works.

4.3 The method statement shall be presented to the consultant and approved in writing by the consultant prior to commencement of the works.

4.4 When the work is complete (including all appropriate recording) and the Contractor has presented the Consultant with the written record of work and materials the work shall be signed off by the Contractor and the Consultant.

**STRUCTURAL ASSESSMENT  
OF  
ARCHAEOLOGICAL MONUMENTS  
IN  
FINGAL COUNTY COUNCIL OWNERSHIP**

**GARRISTOWN CHURCH, GARRISTOWN (NO. 1)**



**RECORD OF MONUMENTS AND PLACES (RMP) DU003 – 011**

**RECORD OF PROTECTED STRUCTURES (RPS) - 121**

**Dermot Nolan & Associates  
Historic Buildings Consultants  
& Consulting Engineers  
'Claremount'  
Meath Road  
Bray  
Co. Wicklow  
Tel: 01-276 2626  
Email: [dnolanconservation@eircom.net](mailto:dnolanconservation@eircom.net)**

## 1.0 INTRODUCTION

The Church was inspected on the 2<sup>nd</sup> November 2011. The building is just outside the village of Garristown on an elevated site, surrounded by a graveyard and is easily accessible. The weather was dull and rainy on the day of the visit.



Entrance door

## 2.0 DESCRIPTION

The Church is a simple parish Church. The founding date is not known although it is reported that it replaced a medieval Church. A Church is shown at the same location on Roque's map of the County of Dublin 1760. A glebe house was built in Garristown in 1791 although it was in ruins in 1837 (Lewis). Lewis describes the Church as "plain". It seems likely that it was built at some time in the eighteenth century.

The Church is built from random rubble limestone with cut stone pointed arches. The only decorative features are a hood moulding and chamfered architrave at the entrance door in the south side of the tower, a single string course on the tower and modest battlements and corner pinnacles on the tower. The Church is ca. 14 x 8 metres (external) and the tower is 4.8 x 4.1. The tower is about 13 metres high and the nave walls ca. 4.6 metres high.





North Elevation

There are three large pointed and splayed windows on the south side of the nave and a large pointed east window. The tower has an entrance door on the south side and a blocked up window at ground floor on the west side. There are segmental windows on three sides of the tower at first floor and a rectangular opening into the Church roof area on the east side. The segmental windows are blocked, except on the south side. At belfry level there are four large pointed windows which have been blocked, apart from narrow central slots on each.



South Elevation



West elevation of the tower

The Church and tower are roofless and there are no traces of timber elements. It is likely that the windows were timber. The building may have been plastered. The building generally was re-pointed in lime or a lime/cement mix. However the north wall was re-pointed in cement and much of this has fallen out.



East Gable

### 3.0 CONDITION

The cills and gable copings have been removed from the nave. The walls are generally in good condition with no bulges or out-of-plumb. However there are areas of voiding where interior mortar has been washed out – for example, along the base of the south nave wall. There is some vegetation growing at the parapet in the tower on the east and south sides, on the tops of the south and north nave walls and on the east gable. There is a very thin timber head over the first floor opening on the east side of the tower.



East wall of tower

The tower walls appear to be damp and there is a covering of green mould on the interior walls. There is some masonry disintegration at high level on the west and east sides of the tower. There is vertical cracking for virtually the full height of the tower on the west side and a diagonal crack over the entrance door on the south side. These cracks may be connected and may be caused by subsidence at the south west corner. There is also cracking and voiding near the east end of the tower north wall. An area of wall below the string course on the east side of the tower requires to be pointed.



Green mould on the interior of the tower wall

Most of the cracking and minor disintegration in the masonry is probably due to vegetation growing in the wall in the past. Where this occurred and the vegetation was removed or died off, the resulting disruption of pointing and mortar would have permitted ingress of moisture. This, in turn, can lead to washing out of mortar and voiding and disintegration of the masonry. The solution is to point the walls and to fill voids as far as possible. As noted above, the profile of the cracking at the south-west corner of the tower indicates possible foundation subsidence in this area.

**Note  
cracking**



Detail of North tower wall lower level

#### **4.0 VULNERABILITY**

The structure is generally robust and quite sound. The problems noted are typical of buildings of this type which have not been continuously maintained. The cracking in the tower is not severe at this stage but there is a possibility that it is due in part to local subsidence of the wall foundation. If subsidence is occurring it is likely to be very gradual.

It appears that some maintenance is on-going (removal of vegetation). With appropriate initial work, and with a programme of relatively light maintenance, the building can be sustained into the future. There was no evidence of vandalism on this site and no special protective measures are required at present. On a scale of 1 to 5 the vulnerability may be considered to be at level 2-3.



Note  
cracking

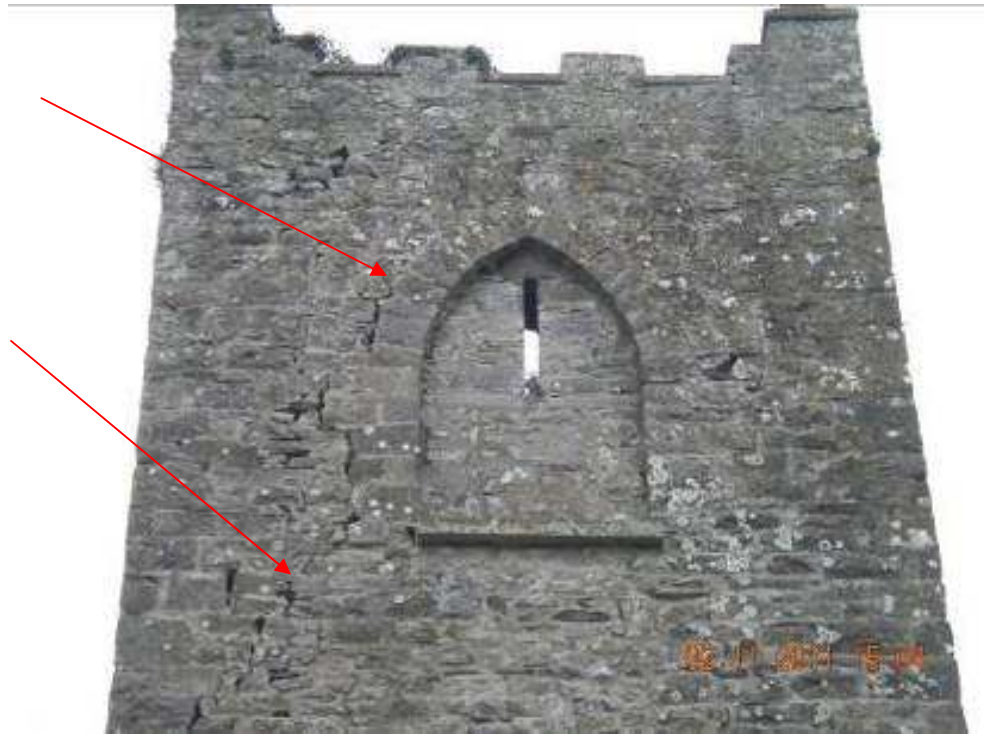

North tower wall upper level

## 5.0 RECOMMENDED WORKS

Specific works are suggested below to address and repair cracking in the tower. It is also recommended that the wall and parapet tops should be provided with a mortar capping to minimize ingress of moisture into the walls. While the cracks in the wall should be filled and loose masonry stabilized by pointing and re-setting as necessary, it is not recommended that crack movement monitoring devices be installed at this stage. Indeed it would probably not be possible to install such devices securely on the loose and displaced masonry. The cracks should be repaired and if they re-occur in say, a year, it may be appropriate to install such devices at that time.

If these works are carried out, together with removal of vegetation and general re-pointing, the future of the building will be secured and a management programme of minimal annual maintenance will suffice to protect the building.

The works proposed, in particular the proposal to excavate a trial pit and the possible installation of a 'French' drain will require Ministerial Consent. Proposed works involving excavations must be supervised by a licensed archaeologist.

Cracking



West wall of tower

- 5.1 An exploratory trial pit should be opened at the south-west corner of the tower to determine the subsoil conditions. The trial pit must be inspected by an engineer to determine what action might be required. The trial pit location (and that of any subsequent works) must be carefully chosen to avoid disturbing graves.

The outcome of this investigation may be a recommendation to underpin part of the tower foundation. Alternatively, or perhaps additionally, there may be a recommendation to install a 'French' drain around the tower. Where soil in the vicinity of a foundation becomes saturated it can become soft and cause subsidence. A 'French' drain can assist in drying the soil and preventing future saturation.

- 5.2 Vegetation on the wall and parapet tops and on the wall faces should be sprayed with biocide and removed.
- 5.3 The wall and parapet tops and the window cills should be protected by capping with lime mortar using an appropriate mix.
- 5.4 The larger cracks on the north, south and west tower walls which are shown on the accompanying drawing should be filled in. Generally the larger cracks should be tied by installing stainless steel mesh in the joints on either side at spacings to be decided by the engineer on site. The locations where ties are required are shown on the drawing.

- 5.5 The entire building should be repointed on both the inside and outside faces of the wall. In some areas where masonry has been loosened or become detached from the body of the wall it will be necessary to take out and reset stones.
- 5.6 On the north wall (of the nave and tower), where cement pointing was installed in the past, this should be removed prior to repointing.
- 5.7 When the wall is being repointed areas of voiding should be identified. These should be filled as far as possible by pouring an appropriate lime-based grout into the wall. This is a difficult and specialized operation which must be specified and supervised by the engineer.

---

DERMOT NOLAN BA BAI Eur Ing CEng MIEI

**CHARTERED ENGINEER AND  
HISTORIC BUILDINGS CONSULTANT**

## **APPENDIX**

### **DRAWINGS AND SITE LOCATION**



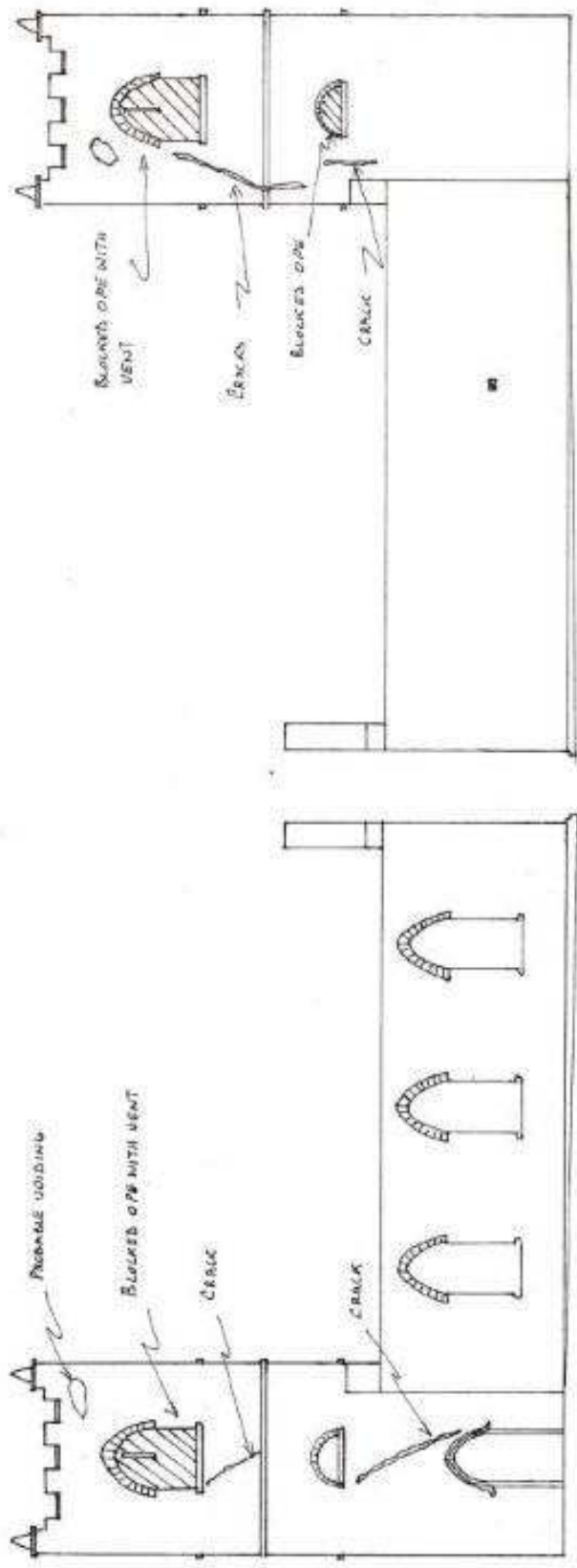

NORTH ELEVATION

SOUTH ELEVATION

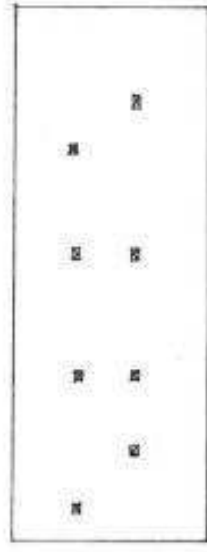

SOUTH FACE OF NORTH WALL

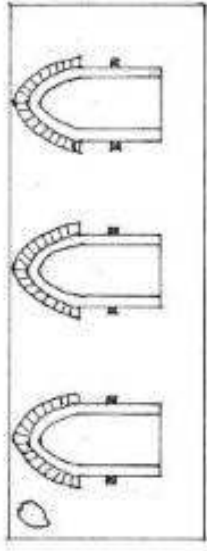

NORTH FACE OF SOUTH WALL

**Dermot Nolan & Associates**  
 Architects, Building Consultants and Quantity Surveyors  
 100, Ballymore Park, Dublin 4  
 Tel: 01 454 4111  
 Fax: 01 454 4112  
 Email: info@dermotnolan.ie

BARRISTOWN CHURCH (2011)  
 Nov 2011  
 SCALE: 1:100

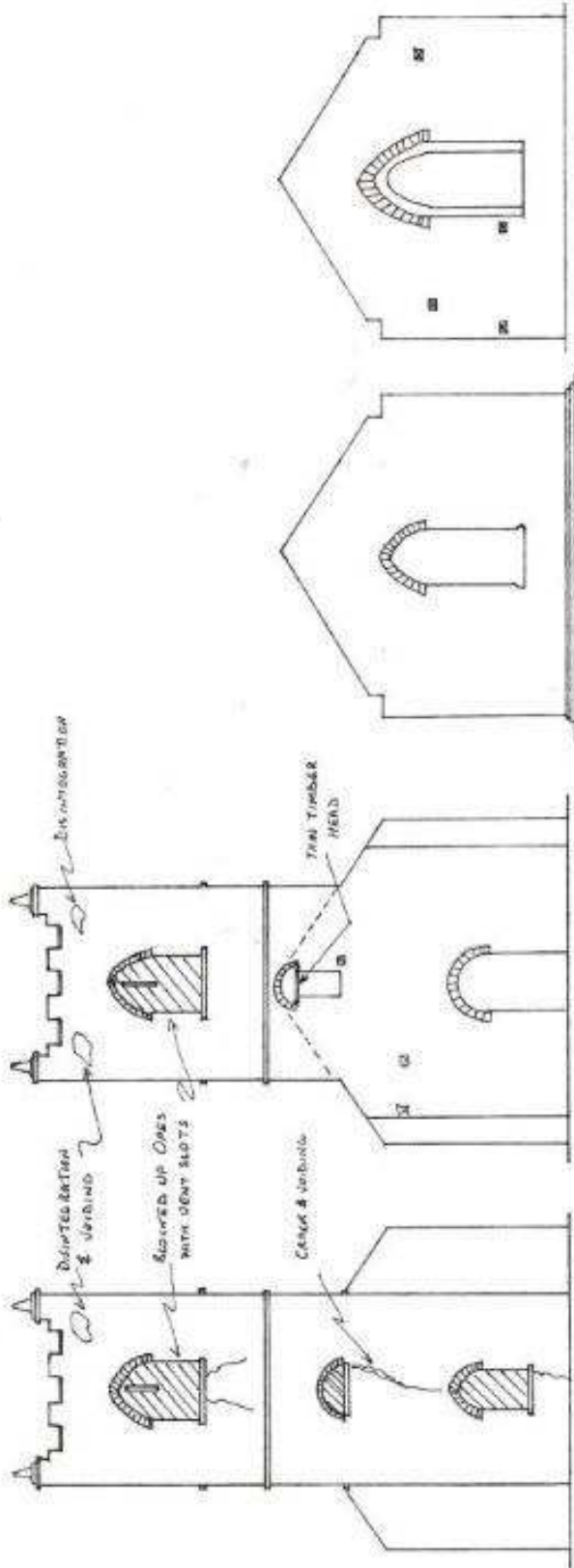

West Elevation

East Elevation of Tower

East Cable (East Face)

East Cable (West Face)

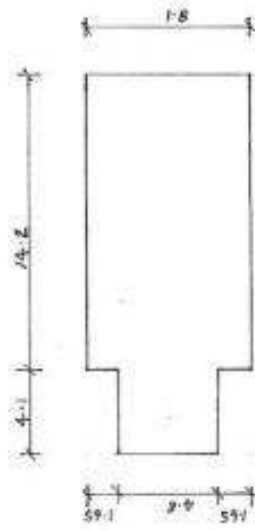

PLAN  
1:200

GARRISTONIAN CHURCH  
(DRG 2)

SCALE: 1:100 LAND

Nov 2011

**Dermot Nolan & Associates**  
 Historic Building Conservation and Consulting Engineers  
**DERMOT NOLAN**  
 64, Duffryn Ave, Chagallville  
 "Cherrywood", Church Road, Sarsfield, Co. Wicklow  
 Tel: +353-01-278 2624 - Mobile: 087-5171319  
 Email: [dermot@dermotnolan.ie](mailto:dermot@dermotnolan.ie) www: [dermotnolan.ie](http://dermotnolan.ie)



**Comhairle Contae Fhine Gall**  
Fingal County Council

**Record of Protected Structures**

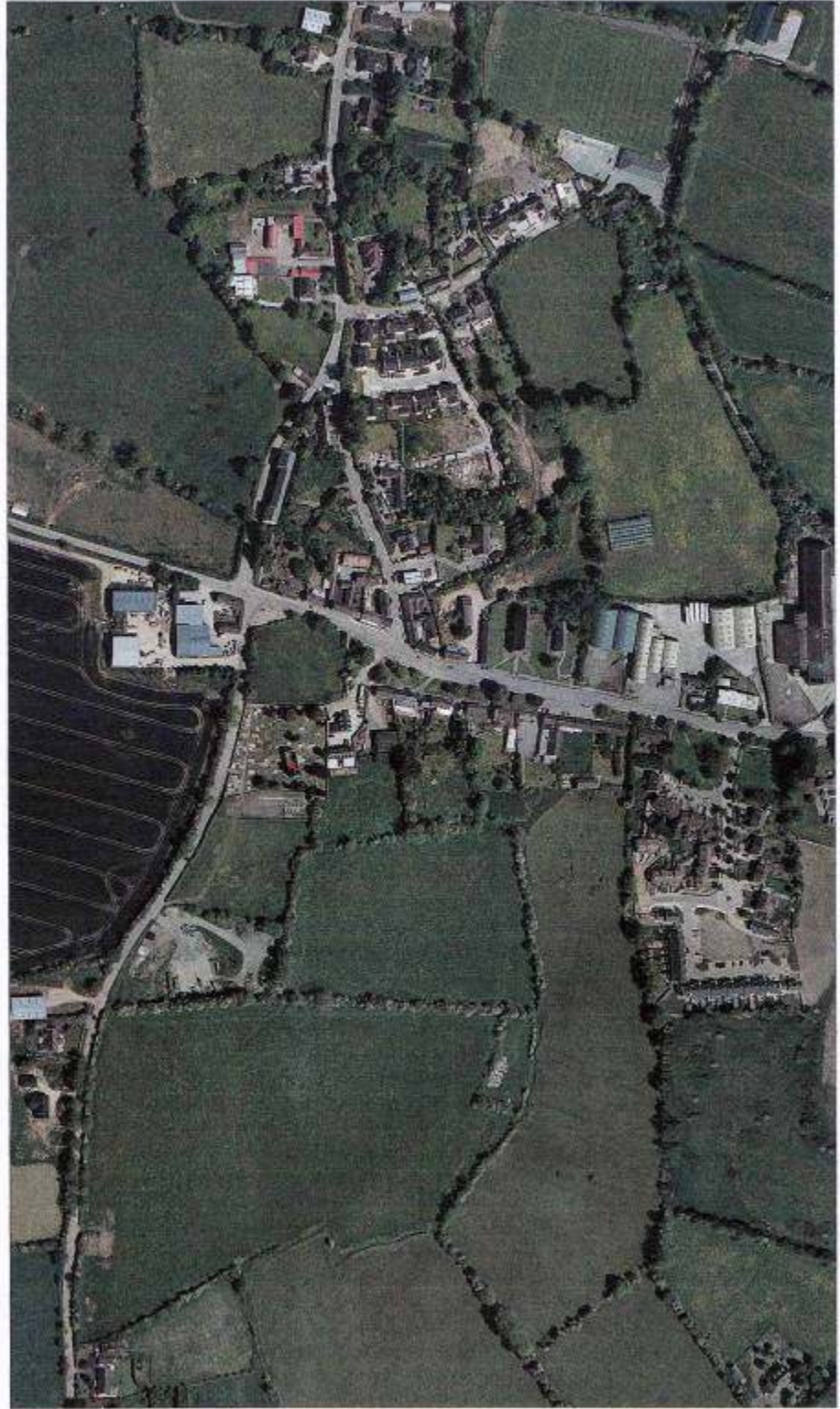

RPS No. 121 Garristown Church, Garristown, Co. Dublin



Scale 1:1000





Setting of Garristown church

**STRUCTURAL ASSESSMENT**  
**OF**  
**ARCHAEOLOGICAL MONUMENTS**  
**IN**  
**FINGAL COUNTY COUNCIL OWNERHIP**  
**GRALLAGH CHURCH (No 2)**



(View from the east)

**RECORD OF MONUMENTS AND PLACES (RMP) - DU007 - 001**

**RECORD OF PROTECTED STRUCTURES (RPS) - 141**

**Dermot Nolan & Associates**  
**Historic Buildings Consultants**  
**& Consulting Engineers**  
**'Claremount'**  
**Meath Road**  
**Bray**  
**Co. Wicklow**  
**Tel: 01-276 2626**  
**Email: [dnolanconservation@eircom.net](mailto:dnolanconservation@eircom.net)**



## 1.0 INTRODUCTION

Grallagh Church was inspected on the 2<sup>nd</sup> November 2011. The structure is located in a graveyard which is still used and surrounded by agricultural land. The site is easily accessible. The weather was poor during the visit with quite heavy rain.

## 2.0 DESCRIPTION

This monument comprises the remains of a medieval 13<sup>th</sup> century parish Church apparently already ruinous by the time of the Civil Survey (1654 – 1656). The Church is located in a sub-rectangular graveyard bounded by ditches on three sides and a road on the east side. A flat hollow approximately 6.0 x 6.0 appears to coincide with the interior (or part of the interior) of the former Church. This area is bounded by part of the original west wall (approximately 5.4 metres long x 2.6 metres high) and by low banks of earth and stone on the other sides. These banks are ca. 1.0 metres high and appear to include masonry from the Church walls.



East end of the church site

The banks on the north and south sides are ca. 3.0 metres wide. The bank on the east side is about 8.0 metres wide and is supported on the east by a low concrete retaining wall. There is one grave in the hollow. A 19<sup>th</sup> century grave marker has been built into the east face of the wall. There is a depression in the top of the east wall near the centre which appears to be a remnant of a former window identified and recorded by Walsh in 1888.



19th century grave marker fixed to the West wall

The structure is severely degraded and much of it has been reduced to loose rubble some of which is remote from its original position on the site. As a result, and because of the prevalence of trees and dense vegetation, it is difficult to identify the original features and even the footprint can only be traced in an outline manner.



North end of the West wall (West face)

### 3.0 CONDITION

The remaining west wall is in poor condition, although ivy has been removed from the faces of the wall in the recent past. The following defects were noted:

- a) Small trees are growing at the south end and causing serious disruption to the masonry.
- b) The north end is disintegrating and fallen stones lie at the foot of the wall.
- c) Vegetation is growing along the top of the wall and disrupting masonry.
- d) An area of wall face ca. 0.7 wide x 1.2 high has collapsed on the east side.
- e) The wall is out-of-plumb and leaning ca. 100mm towards the west.
- f) Fallen masonry has been moved and some of it is now grown over and covered by grass and earth.



North end of West wall (note the wall leans to the West)

### 4.0 VULNERABILITY

This site is very vulnerable because it is in an open public area and the site features are relatively indistinct. The remaining structure is disintegrating due to weathering and vegetation. Historic masonry stones could easily be moved or taken away. The site appears to have been subject to 'tidying' ie collecting and moving stones from their original locations. This structure will be lost if action is not



taken in the near future. This site ranks at the highest level of vulnerability – level 5.



West end of West wall

## 5.0 RECOMMENDED WORKS

Because of the severe damage that has been suffered by this site it will be impossible to do more than carry out very basic stabilization of the remaining structure. Because of the extensive active vegetation and voiding and instability of the masonry there is a risk that any intervention may be destructive in some degree. Therefore works must be very carefully planned and carried out in a balanced way in the knowledge that in conserving the most important parts of the special character other parts and some historical evidence may be lost. Where large roots are embedded in the masonry a particular problem arises. If the roots are not removed they will destroy the masonry. If they are treated with biocide they will die and rot and may eventually result in the collapse of the adjacent stones. Generally biocide should be used but a drawn record of the masonry in the vicinity of the root should be made. Ministerial consent will be required for all the works proposed.



South end of West wall (West face)

- 5.1 The small trees at the south end of the wall should be removed. They should be cut back initially at the face of the masonry and an assessment should be made of the likelihood of roots embedded in the masonry. These should be dealt with in accordance with the principles of the preamble to this section. Removal of roots should be done by a stonemason experienced in conservation work and the displaced stones should be kept and built back in position to the extent possible.
- 5.2 All vegetation should be sprayed with biocide and carefully cut out. Vegetation should never be pulled from the masonry.
- 5.3 The damaged wall face should be rebuilt. The existing wall is Very roughly coursed with discontinuous courses. This pattern should be followed in reconstruction. There may be no original mortar left in the wall. In any event because of the obvious paucity of original material it would not be appropriate to remove a sample of the mortar for testing. The mortar used for re-building should be weak putty lime mortar with roughly graded sand.
- 5.4 The top of the wall should be cleaned off and provided with a protective mortar capping. This should be hydraulic lime mortar (NHL 5.0, 1:3).
- 5.5 The wall (including the ends) should be pointed using weak lime putty mortar and roughly graded aggregate in the proportion 1:3 with flush joints.



Area of collapsed masonry

Collapsed masonry at base of East side of the West wall

- 5.6 An information sign should be erected on the site to alert the public to the significance of the monument. This should be erected inside the wall at the gate.
- 5.7 When the vegetation is removed an assessment of the stability of the out-of-plumb wall should be made by an engineer experienced in conservation work and a decision should be made on whether remedial measures are necessary.

---

DERMOT NOLAN BA BAI Eur Ing CEng MIEI

**CHARTERED ENGINEER AND  
HISTORIC BUILDINGS CONSULTANT**

# **APPENDIX**

## **DRAWINGS AND SITE LOCATION**

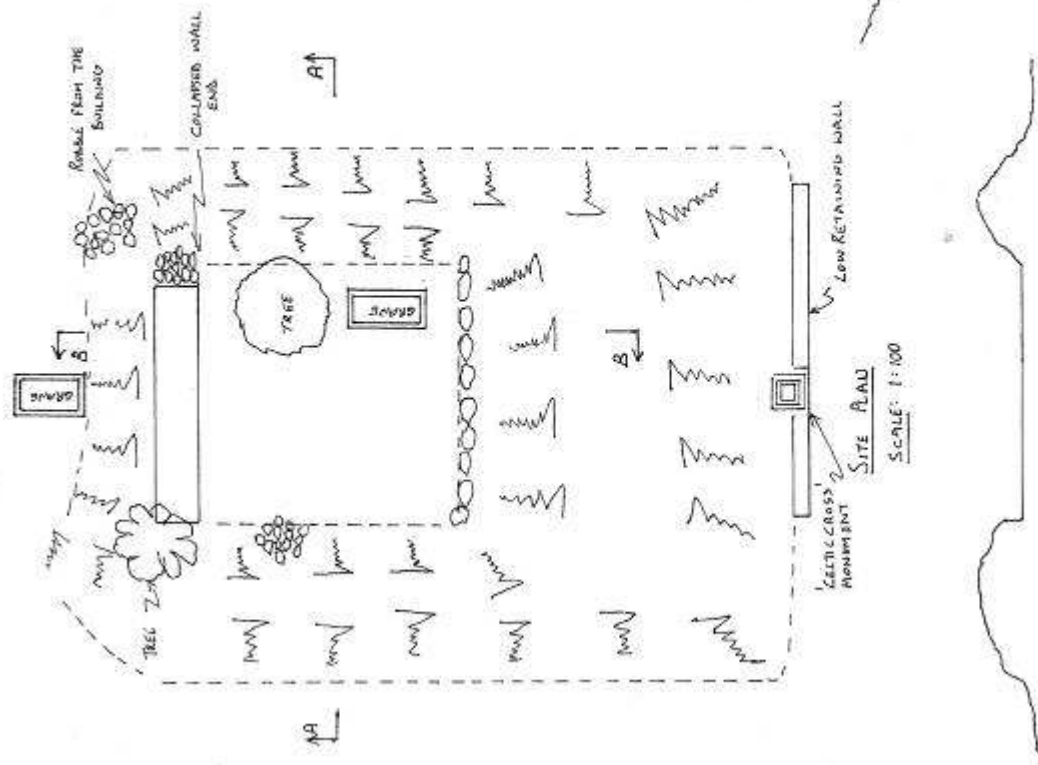
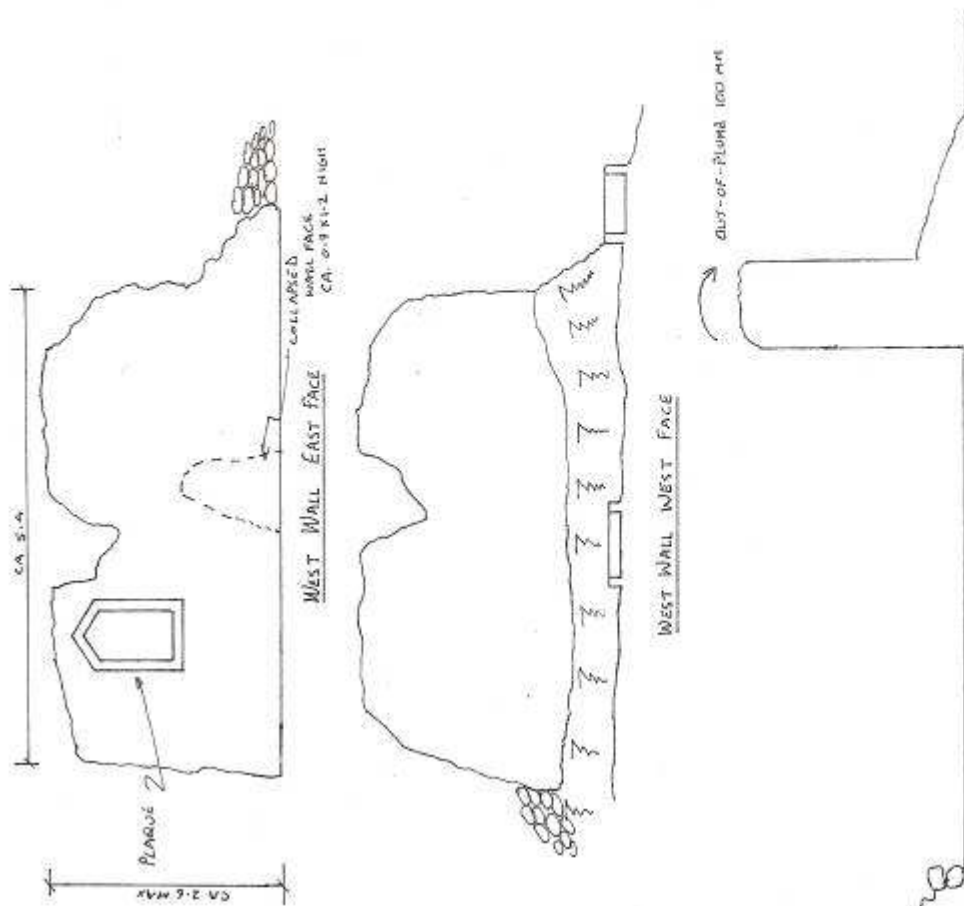

SECTION A-A  
SCALE: 1:100

SECTION B-B

**Dermot Nolan & Associates**  
 Historic Building Consultants and Consulting Engineer  
**DERMOT NOLAN**  
 BA BAAT Bar Ing CEng MInstE

"Chartered", North Bank, Bray, Co. Wicklow  
 Tel: Fax 01-336 2828 - 33661487-331119  
 Email: d.nolan@dermotnolan.ie; www.dermotnolan.ie

**GERALLAGH CHURCH**  
 SCALE: 1:50 AND  
 NOVEMBER 2011



**Record of Protected Structures**



RPS No. 141 Grallagh Church, Grallagh, Co. Dublin

 N  
Scale 1:1000



Setting of Grallagh church



**STRUCTURAL ASSESSMENT  
OF  
ARCHAEOLOGICAL MONUMENTS  
IN  
FINGAL COUNTY COUNCIL OWNERHIP  
STELLA'S TOWER (No 3)**



(View from the south-west)

**RECORD OF MONUMENTS AND PLACES (RMP) - DU008 - 030**

**RECORD OF PROTECTED STRUCTURES (RPS) - 521**

**Dermot Nolan & Associates  
Historic Buildings Consultants  
& Consulting Engineers  
'Claremount'  
Meath Road  
Bray  
Co. Wicklow  
Tel: 01-276 2626  
Email: [dnolanconservation@eircom.net](mailto:dnolanconservation@eircom.net)**



## 1.0 INTRODUCTION

Stella's tower is a fifteenth century tower house so named because it was historically associated with Jonathan Swift's Stella. (Stella was the name given by Swift to Esther Johnson, a close friend who he met when she was very young and with whom he maintained a close relationship during her lifetime. He is buried beside her in Saint Patrick's cathedral, Dublin).

The site was inspected on the 4<sup>th</sup> November 2011. The castle is isolated in a large field used for tillage farming. The land around it is very flat and the castle is an impressive feature on the landward approach to the village of Portrane. The ca 1840 Ordnance Survey map shows what appears to be a rectangular bawn wall around the castle but no ancillary buildings. The ca 1900 map shows the castle as it is today. The weather was fine and sunny on the day of the visit.

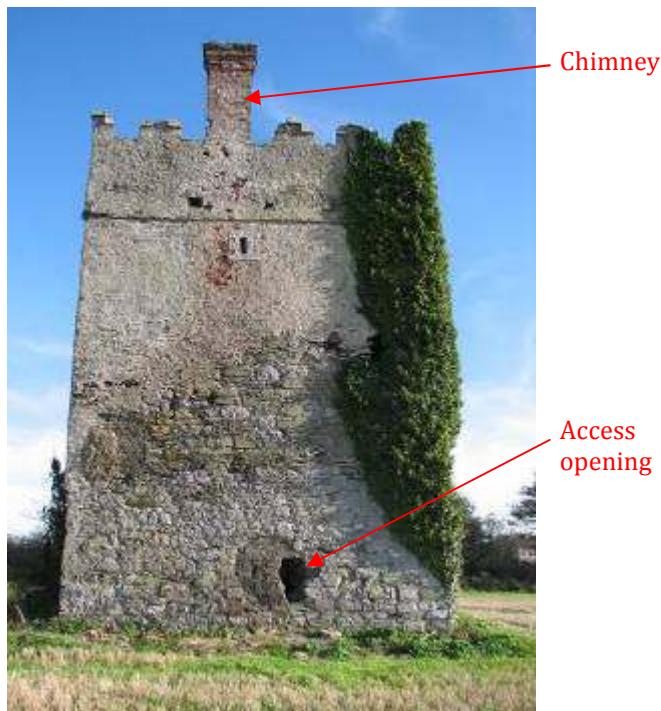

West elevation of the castle

## 2.0 DESCRIPTION

The entrance door is on the south elevation but is blocked with concrete blocks. There is a hole in the west wall at ground level but it does not provide safe access and as a result, the interior could only be inspected by looking through this wall opening. The tower is rectangular (7.4 x 6.1) with a protruding stair tower (1.5 x 2.4) in the north-east corner. The tower is ca. 12 metres high with

battlements, a raised roof over the stairwell and a very tall chimney on the west wall.

The tower has a barrel vault at first floor and various interior features are recorded in the RMP description. The tower was extensively refurbished in the seventeenth century and brick features were added, including the battlements and the chimney.



Stair  
tower

East Elevation

The south and east sides, including the stair tower, are entirely covered in ivy and could not be examined. Parts of the west and north sides are also covered in dense ivy. The castle was plastered in lime but much of the plaster is now degraded or lost.

The west wall has an opening at ground floor as mentioned above. It appears to have been a smaller opening which was enlarged over time. It may have been associated with a garderobe chute. This would have to be confirmed by inspection of the interior.



South elevation

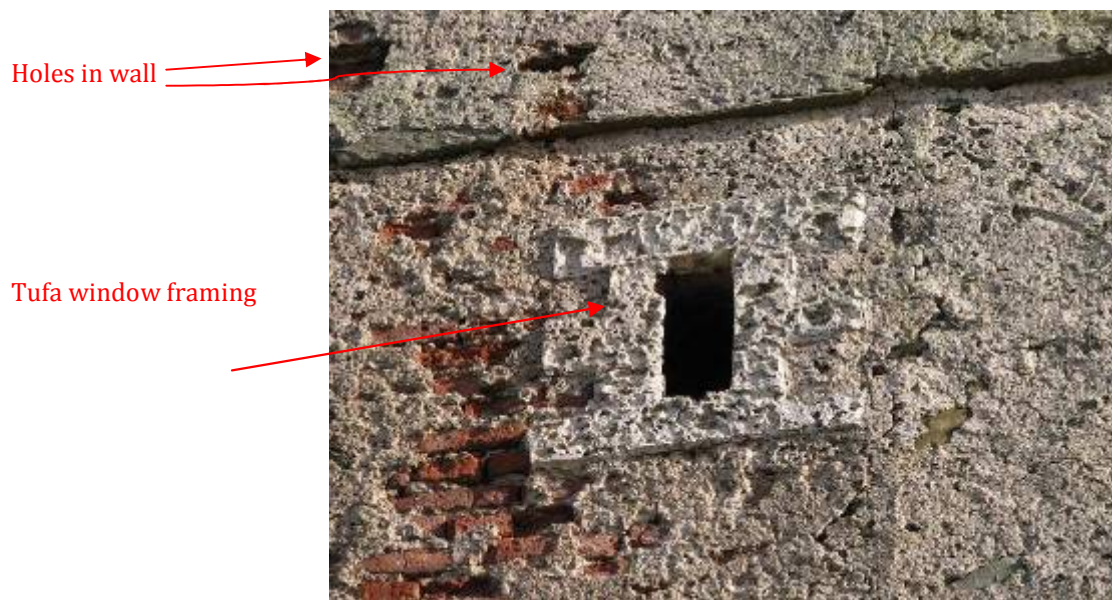

Tufa framed window on West wall

There appears to be a blocked up opening at the north end of the wall at first floor. There is a hole in the wall at the south west corner at second floor level, partially obscured by ivy. There is a central small window just below the string course which is

decoratively framed in cut tufa stone. There are two holes in the masonry above this window.



The chimney from the South

The brick chimney is a very large and impressive structure and an important example of how such buildings were modified in the seventeenth and early eighteenth centuries to improve living conditions and convenience. The chimney is off-centre on this wall. It appears to be about 3.0 metres high and has a broad stepped crown. It is unclear whether the chimney was plastered.

The north wall has a masonry construction which is similar to a shallow buttress against it near the east end. There is a large area of repaired masonry above this which appears to be plastered in cement. To the right of this at about second floor level, there is a lancet window which appears to have widened due to the collapse of the right reveal. Above this, there is a large rectangular window opening with its head at string course level. To the right of this at the west side there is a hole in the wall, which may have started life as a discharge point for roof rainwater. There is also a small hole above and to the left of the large window opening.





North elevation

Due to ivy there is nothing visible on the east wall apart from a high level rectangular window ope. There appears to be a second similar window directly below this. The ivy on the south wall has been cut up to a height of 3 - 4 metres but is growing back. The original entrance door is on this elevation but could not be clearly seen because of the vegetation. No other features are visible on this wall.

### **3.0 CONDITION**

It is only possible to comment on those elements which could be clearly seen. This excludes most of the castle which cannot be examined until the ivy is removed and safe access is provided into the interior.

Hole



Hole in south-west corner partly hidden by ivy

The walls appear to be in reasonable condition with no visible evidence of subsidence or excessive bulging. In the absence of a roof, it is likely that the wall walks and battlements are being damaged by vegetation growth and that less robust elements of internal masonry, such as partition walls, have suffered from water damage.

The chimney has long been considered a cause for concern by the technical staff of the County Council. The capping is badly damaged and the brick crown assembly has also been badly affected by water. The north east corner of the chimney shaft above the battlements has collapsed. In its present condition the chimney is extremely vulnerable to rooting vegetation, mortar washout, brick erosion, ice action and wind loading. There is no doubt that the degradation of the chimney is on-going and that there is a real risk of sudden collapse of sections of it or of the whole chimney.

#### **4.0 VULNERABILITY**

There is no doubt that the extensive ivy is damaging the integrity of the structure and the damage will be on-going until the ivy is removed. In the absence of a roof, structures of this type are vulnerable to gradual degradation due to rainwater passing through. The water also encourages vegetation to grow in joints and crevices in the masonry leading to further degradation. Unless the ingress of water is controlled, structures of this type will eventually collapse – sometimes sudden collapse of large sections of masonry can occur.



The brick chimney



View of the chimney from the north

The brick chimney is in a very precarious state. There is a serious danger that it could blow down in strong winds if remedial action is not taken. It is impossible to predict when this might happen but there is no doubt that degradation and weakening of this feature is on-going.

At present public access to the interior is possible through the hole in the west wall. Apart from the danger to the public this makes the interior of the building vulnerable to vandalism. Because of the relatively isolated but accessible site of the tower the exterior is vulnerable to vandalism (fire, graffiti, removal of loose stones etc)

On a scale of vulnerability of 1-5 the chimney may be considered to be level 5 and the rest of the inspected structure at level 3.

## **5.0 RECOMMENDED WORKS**

The recommendations below are by necessity outline because the interior and upper levels have not been examined. The works in this case will have to be carefully planned and carried out over an extended period of time. The first priority will be to provide safe access to the interior and to the upper levels to permit examination and survey of the interior features and structures and, in particular, of the chimney. Extensive scaffolding will be required to remove the ivy and to repair the masonry. Because of the necessary sequencing and phasing of operations (eg removing the ivy) it may be necessary to erect and remove the scaffolding several times.

Ministerial consent will be required for the works proposed apart from removal of vegetation and investigative work.

- 5.1 Safe permanent access into the tower should be provided to permit a full condition survey of the interior and upper levels to be carried out and to facilitate on-going monitoring. The access should be secured by a strong steel grating. A grating is preferable to a solid steel door as it facilitates the flow of air through the building.
- 5.2 The ivy should be removed from the building. This should be done on a phased basis. The walls should be sprayed with 'Roundup' or similar appropriate biocide which can destroy the roots. This application may have to be repeated several times. The vegetation should then be cut off as near the roots as possible and be allowed to decay. Finally the vegetation should be carefully removed from the wall without pulling which can dislodge mortar and stones.
- 5.3 The chimney should be temporarily supported as a matter of urgency. This will require scaffolding and support structures inside the tower and probably outside. Vegetation should not be removed from the chimney before it is propped.



- 5.4 All areas of weak or collapsed masonry on the exterior walls should be made good and filled in. This will include holes in the wall where masonry has disintegrated and degraded window and door surrounds. In some cases re-pointing will be adequate. In others it will be necessary to take down and re-build areas of masonry. Where this is necessary a careful photographic and measured record should be made prior to the work and used in re-building. Where stone has to be imported to site the source should be approved by the conservation consultant responsible for the works.
- 5.5 Vegetation and soil should be removed from the battlements and wall walks and they should be pointed and capped with a lime capping to prevent water ingress and future plant growth. Hydraulic lime mortar (NHL 5.0) should be used to form a rounded capping which will dispose of rainwater.
- 5.6 When access is available and the brick chimney is stabilized it should be carefully measured and recorded. The mortar should be analysed. An appropriate conservation and repair strategy should be devised by an experienced conservation engineer. This may involve stabilizing the structure as is or possibly re-building the lost and damaged sections using appropriate materials.
- 5.7 When the upper levels of the castle are surveyed and drawn a plan should be prepared for management and disposal of rainwater to ensure that it does not damage the structure in future. This may involve the provision of appropriate spouts or interior rainwater pipes.
- 5.8 The interior of the building should be carefully checked and any damaged masonry – particularly arches and load bearing walls, should be repaired and re-pointed as described in 5.4 above.
- 5.9 An on-going inspection regime should be set up providing for annual site visits and condition reports by a conservation professional.

5.10 The opening at ground level on the west wall should be blocked up at the earliest opportunity to prevent unauthorized access into the tower.

---

DERMOT NOLAN BA BAI Eur Ing CEng MIEI

**CHARTERED ENGINEER AND  
HISTORIC BUILDINGS CONSULTANT**

# **APPENDIX**

## **DRAWINGS AND SITE LOCATION**

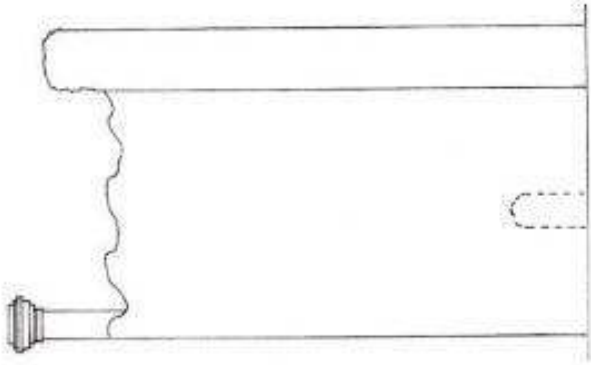

SOUTH ELEVATION

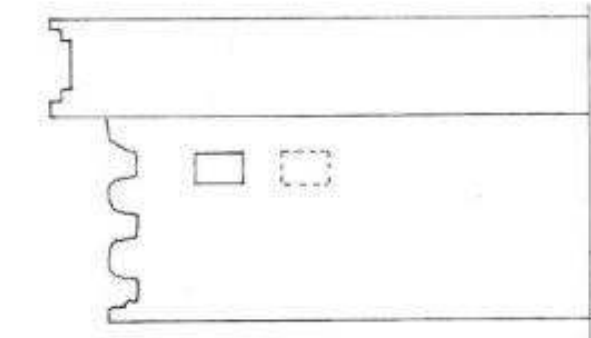

EAST ELEVATION

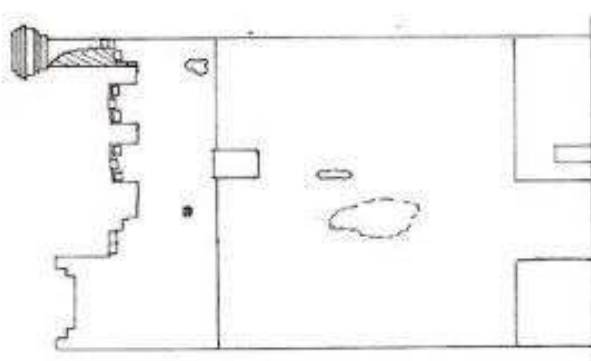

NORTH ELEVATION

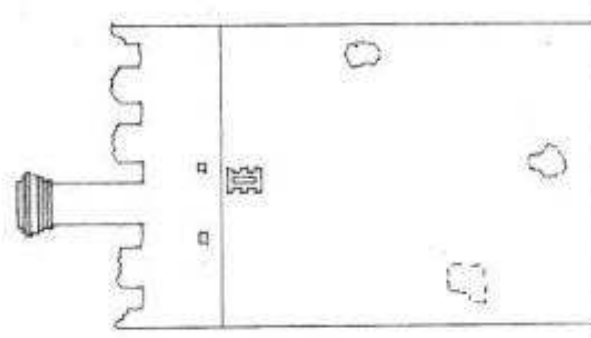

WEST ELEVATION

STELLA'S TOWER  
 SCALE: 1:100  
 Nov. 2011

PLAN

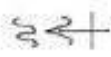
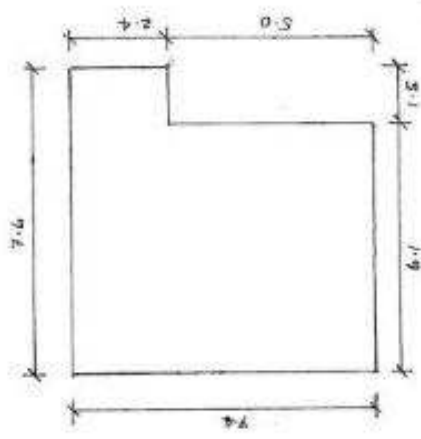

*Permot Nolan & Associates*  
 Dublin Building Consultants and Contracting Engineers  
 BERMOT NOLAN  
 6A BAI DARGUIG MHI  
 DUBLIN 1  
 Telephone: +353 1 234 2028 • Mobile: 087 2470188  
 Email: [info@permotnolan.com](mailto:info@permotnolan.com)



**STRUCTURAL ASSESSMENT  
OF  
ARCHAEOLOGICAL MONUMENTS  
IN  
FINGAL COUNTY COUNCIL OWNERHIP  
LANESTOWN CASTLE (NO 4)**



(South elevation)

**RECORD OF MONUMENTS AND PLACES (RMP) - DU012 - 004**

**RECORD OF PROTECTED STRUCTURES (RPS) - 493**

**Dermot Nolan & Associates  
Historic Buildings Consultants  
& Consulting Engineers  
'Claremount'  
Meath Road  
Bray  
Co. Wicklow  
Tel: 01-276 2626  
Email: [dnolanconservation@eircom.net](mailto:dnolanconservation@eircom.net)**



## 1.0 INTRODUCTION

The castle is a typical tower house which carries evidence of habitation over a long period of time. The Ordnance survey maps of ca 1837 and ca 1900 appear to show the castle as it is now. However there is clear remnant evidence of seventeenth or eighteenth century building work in the form of extensions to the east of the present structure.

The castle is in the grounds of Newbridge House, a country house and grounds in the ownership of Fingal County Council. The castle is located in open grassland near the road entrance to the site. The exterior is accessible to the public but the interior is blocked off.



East elevation

The castle was inspected on the 4<sup>th</sup> November 2011. The weather was bright and sunny.

## 2.0 DESCRIPTION

The castle is located in the grounds of Newbridge Demesne. The date of origin is not known but it is probably fifteenth century. The castle is currently inaccessible as the entrances are closed with concrete blocks. Descriptions of the interior layout below are based on information obtained from a website owned by Mr M Mongey. ([www.homepage.eircom.net/mickmongey/index.html](http://www.homepage.eircom.net/mickmongey/index.html))

The tower is rectangular (8.7 x 7.2) with a projecting tower (1.5 x 2.0) at the south-west corner. The tower is ca. 12 metres high with crow's feet battlements in the Irish style which have now lost their

shape to some extent as a result of the loss of copings from the crenellations, by frost action and by rooting vegetation. There are small raised towers over the stairwell in the north-east corner and in the south-west corner.

The tower has two entrance doors – one on the north side and one on the west side. An unusual feature is that there is a second stairs from the door on the west side to the first floor. The main door on the north side gives access to a spiral stair, which serves all the other floors. The first floor is barrel vaulted.



North elevation

The tower appears to have been extensively refurbished in the seventeenth or eighteenth centuries and brick lined window ope were installed. By 1796 there was a large building extending from the east side of the castle. This has been completely demolished but the traces of it are evident on the east face of the castle. The traces indicate that this was a two-storey building accessed from the castle at ground and first floor. The access openings are now blocked up.

The south wall appears to have a blocked up opening at ground level which was probably a window. This wall has a large brick-lined pointed window ope at first floor level and a sandstone ogee window frame at second floor. The sandstone window is probably original and the brick-lined window may be 17<sup>th</sup> or 18<sup>th</sup> century. The west wall has a brick-lined pointed window at first floor matching that on the south side and there are small plain loop windows above and below this window.





West elevation (from the North-west)

There are a number of small loop windows in the southwest projection at various levels. The north wall has a projecting chimney from second floor upwards and two small loop windows in the stairwell tower at the northeast corner. There is a further loop window beside the chimney at second floor.



Sandstone Ogee window on south wall

### 3.0 CONDITION

It is only possible to comment on those elements which can be clearly seen – in this case, the exterior of the castle.



Battlements East Elevation

There is vegetation growing at high level on the battlements – particularly on the east and north side. The battlements have been degraded and have lost mortar on all elevations. Vegetation and possibly trees may be seen through the windows growing in the interior.



North-East corner bulge and hole – east side



On the east elevation there is a bulge in the wall of the northeast corner stairwell at first floor and disintegration of masonry with a substantial hole in the wall. Voussoirs are missing at the springings of the arch over the entrance into the former extension (now demolished). Subsidence has occurred at the southeast corner and a section of masonry has cracked and moved. There is an area of rough masonry at first floor level where the facing has been lost and this requires to be pointed and made good.



East wall – damaged arch springing and missing voussoirs

On the north elevation the failure and bulging of the stairwell wall at the northeast corner is obvious. There is a hole in the wall at high level on the west side, just under the battlements. There is a small tree growing out from the interior through a partially blocked up window beside the chimney.



#### North-East corner bulge and hole – north side

The west elevation is generally in quite good condition. There is some vegetation at high level and degradation of masonry at the cill of the brick surround window.



Hole in masonry at south-east corner

On the south elevation there is a hole in the wall at high level on the east side, just under the battlements. There is degradation of masonry at the cill of the brick-lined window. The subsidence at the southeast corner has resulted in cracking at this wall also.

#### **4.0 VULNERABILITY**

The interior of the building is protected from vandalism because it is inaccessible at present. However there is a danger that the lack of access will discourage regular inspection and maintenance. This in itself may tend to make the building vulnerable.

The exterior of the building is vulnerable to vandalism (removal of loose stones, fires, graffiti etc) because of its somewhat isolated but easily accessible location.





Hole in masonry at north-west corner

There are holes in the wall at various locations and if these are not filled, the masonry around and under them will gradually degrade as mortar is washed out. This applies also to window openings where cills or architraves are missing. There is instability at the stairwell in the northeast corner, which could cause a serious problem if it is not addressed. A collapse at this location could result in the loss of a substantial amount of masonry and of the spiral stairs inside. The subsidence at the southeast corner could also constitute a serious problem in the long-term if it is not addressed.



Subsidence at South-East corner

Vulnerable areas of the interior would include the wall walks behind the battlements where, in the absence of a roof, rain falling

on flat areas will encourage growth of vegetation with associated disruption of masonry.

This monument is vulnerable at present because there are structural problems which could lead to collapse of sections of masonry if they are not addressed.

On a scale of vulnerability of 1-5 the structure may be considered to be at level 3-4.

## **5.0 RECOMMENDED WORKS**

The recommendations below are by necessity outline because the interior and upper levels have not been examined. The works in this case will have to be carefully planned and carried out over an extended period of time. The first priority will be to provide safe access to the interior and to the upper levels to permit examination and survey of the interior features and structures and, in particular, of the stairs and of any vault structures. Extensive scaffolding will be required to remove the ivy and to repair the masonry. Because of the necessary sequencing and phasing of operations (eg removing the ivy) it may be necessary to erect and remove the scaffolding several times.

Ministerial consent will be required prior to carrying out the proposed works except for providing access and removing vegetation.

- 5.1 Safe access should be provided to the castle to permit a full condition survey of the interior to be carried out and to permit on-going monitoring and maintenance. The access should be secured by a strong steel grating. (It is preferable to use a grating rather than a solid door to facilitate flow of air through the building).
- 5.2 Vegetation should be removed from the battlements and wall walks and they should be pointed and capped as necessary to prevent water ingress and future plant growth. After removal of vegetation and soil horizontal surfaces should be protected by sloping or rounded mortar cappings shaped to ensure disposal of rainwater away from the building. Hydraulic lime mortar (NHL 5.0) should be used for cappings.
- 5.3 Ivy and other vegetation should be removed from the building. This should be done on a phased basis. The walls should be sprayed with 'Roundup' or similar appropriate biocide which can destroy the roots. This application may have to be



repeated several times. The vegetation should then be cut off as near the roots as possible and be allowed to decay. Finally the vegetation should be carefully removed from the wall without pulling which can dislodge mortar and stones.

- 5.4 The areas of damaged and holed masonry identified in the condition section should be repaired, filled and pointed. In particular, all window reveals and the holes in the exterior walls at high level on the north and south walls and at the northeast corner.

In some cases pointing will be adequate. In others it will be necessary to take down and re-build areas of masonry. Where this is necessary a careful photographic and measured record should be made prior to the work and used in re-building. Where stone has to be imported to the site it should match the original and the source should be approved by the conservation consultant responsible for the job.

- 5.5 The bulge in the wall at the northeast corner should be fully investigated. It may be necessary to take down and re-build a section of wall masonry. This corner appears to contain a spiral stair and any re-building will involve temporary propping of the stair and may require repairs to the stair as well as to the wall. The procedures listed in 5.3 above should be followed in any re-building works.
- 5.6 The missing voussoirs at the arch springing on the east wall should be replaced.
- 5.7 The area of damaged masonry facing on the east wall should be re-pointed and repaired. It may be necessary to remove and build back some loose stones in this area.
- 5.8 The ground conditions at the subsided area at the southeast corner should be investigated by digging a trial hole. Underpinning or similar remedial work may be necessary. Consideration might have to be given to providing land drains around the building. All excavations would have to be supervised by a licensed archaeologist.
- 5.9 Where inspection of the interior indicates that repairs are necessary, in particular to arches, lintels, load bearing walls, etc., these should be carried out.
- 5.10 A plan should be prepared for management and disposal of rainwater to ensure that it does not damage the structure in

the future. This may involve the provision of appropriate spouts or interior rainwater pipes.

- 5.11 An on-going inspection regime should be set up providing for annual site visits and condition reports by a conservation professional.

---

DERMOT NOLAN BA BAI Eur Ing CEng MIEI

**CHARTERED ENGINEER AND  
HISTORIC BUILDINGS CONSULTANT**

# **APPENDIX**

## **DRAWINGS AND SITE LOCATION**

**APEX SURVEYS**  
 10000 Highway 100  
 Suite 100  
 Dallas, TX 75243  
 (972) 437-8888  
 www.apexsurveys.com

**NOTES:**  
 1. ALL DIMENSIONS ARE IN FEET AND INCHES.  
 2. ALL DIMENSIONS ARE TO FACE UNLESS NOTED OTHERWISE.  
 3. ALL DIMENSIONS ARE TO CENTERLINE UNLESS NOTED OTHERWISE.  
 4. ALL DIMENSIONS ARE TO THE CENTERLINE OF THE WALL UNLESS NOTED OTHERWISE.  
 5. ALL DIMENSIONS ARE TO THE CENTERLINE OF THE DOOR UNLESS NOTED OTHERWISE.  
 6. ALL DIMENSIONS ARE TO THE CENTERLINE OF THE WINDOW UNLESS NOTED OTHERWISE.  
 7. ALL DIMENSIONS ARE TO THE CENTERLINE OF THE STAIR UNLESS NOTED OTHERWISE.  
 8. ALL DIMENSIONS ARE TO THE CENTERLINE OF THE PORCH UNLESS NOTED OTHERWISE.  
 9. ALL DIMENSIONS ARE TO THE CENTERLINE OF THE DRIVE UNLESS NOTED OTHERWISE.  
 10. ALL DIMENSIONS ARE TO THE CENTERLINE OF THE FENCE UNLESS NOTED OTHERWISE.

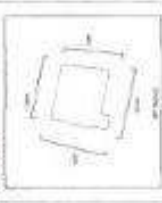

**GENERAL NOTES:**  
 1. ALL DIMENSIONS ARE IN FEET AND INCHES.  
 2. ALL DIMENSIONS ARE TO FACE UNLESS NOTED OTHERWISE.  
 3. ALL DIMENSIONS ARE TO CENTERLINE UNLESS NOTED OTHERWISE.  
 4. ALL DIMENSIONS ARE TO THE CENTERLINE OF THE WALL UNLESS NOTED OTHERWISE.  
 5. ALL DIMENSIONS ARE TO THE CENTERLINE OF THE DOOR UNLESS NOTED OTHERWISE.  
 6. ALL DIMENSIONS ARE TO THE CENTERLINE OF THE WINDOW UNLESS NOTED OTHERWISE.  
 7. ALL DIMENSIONS ARE TO THE CENTERLINE OF THE STAIR UNLESS NOTED OTHERWISE.  
 8. ALL DIMENSIONS ARE TO THE CENTERLINE OF THE PORCH UNLESS NOTED OTHERWISE.  
 9. ALL DIMENSIONS ARE TO THE CENTERLINE OF THE DRIVE UNLESS NOTED OTHERWISE.  
 10. ALL DIMENSIONS ARE TO THE CENTERLINE OF THE FENCE UNLESS NOTED OTHERWISE.

**ELEVATIONS & SECTIONS**

Surveyed on	08/08/2011
Plan	08/08/2011
Scale	1/8" = 1'-0"
Drawn by	DERMOT NOLAN
Checked by	DERMOT NOLAN
Project No.	11111
Sheet No.	1 of 1
Scale	1/8" = 1'-0"
Drawn by	DERMOT NOLAN
Checked by	DERMOT NOLAN
Project No.	11111
Sheet No.	1 of 1

**Dermot Nolan & Associates**  
 10000 Highway 100, Suite 100, Dallas, TX 75243  
 (972) 437-8888  
 www.dermotnolan.com

**DERMOT NOLAN**  
 RA 044 000 000 000 000

10000 Highway 100, Suite 100, Dallas, TX 75243  
 (972) 437-8888  
 www.dermotnolan.com

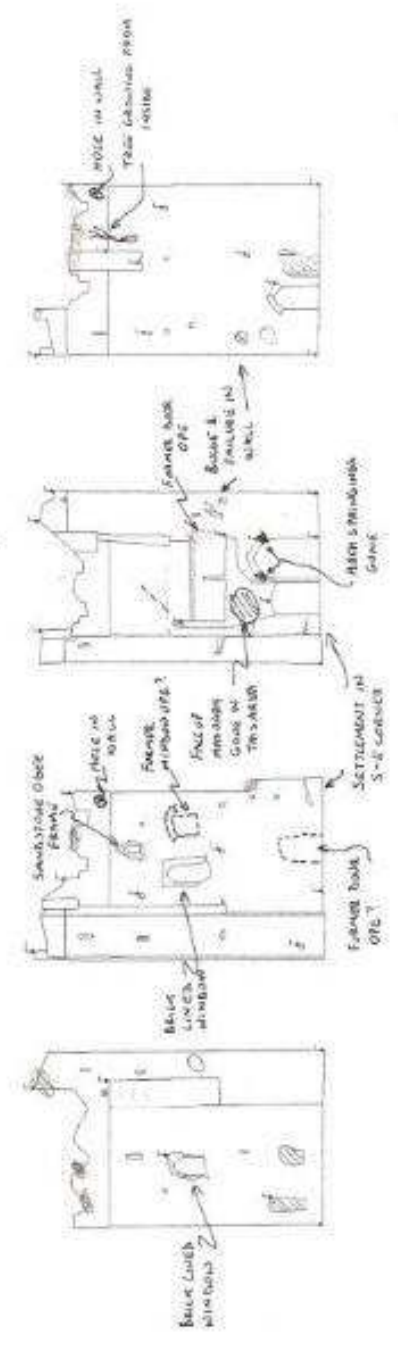

WEST SOUTH EAST NORTH

LAMESTOWN CASTLE  
 08/08/2011

**Record of Protected Structures**



▲ N  
Scale 1:2000

RPS No. 493 Lanestown Castle, Newbridge Demesne, Co. Dublin



**STRUCTURAL ASSESSMENT  
OF  
ARCHAEOLOGICAL MONUMENTS  
IN  
FINGAL COUNTY COUNCIL OWNERHIP  
CHURCH AT MALAHIDE CASTLE (NO 5)**



(West elevation)

**RECORD OF MONUMENTS AND PLACES (RMP) - DU012 - 031**

**RECORD OF PROTECTED STRUCTURES (RPS) - 384**

**Dermot Nolan & Associates  
Historic Buildings Consultants  
& Consulting Engineers  
'Claremount'  
Meath Road  
Bray  
Co. Wicklow  
Tel: 01-276 2626  
Email: [dnolanconservation@eircom.net](mailto:dnolanconservation@eircom.net)**

## 1.0 INTRODUCTION

Malahide Castle Church is a large medieval parish church with an attached priest's house. It was associated with Malahide castle and is an integral part of the Talbot family demesne which is now a public space. The church is located in a graveyard with a surrounding low masonry wall.



North elevation – east end



North elevation – west end

The church was inspected on the 4<sup>th</sup> November 2011. The weather during the inspection was mixed – cloudy with occasional rain.

## 2.0 DESCRIPTION

Castle building at Malahide appears to have been commenced by the Talbot family in the thirteenth century. Many campaigns of construction were carried out on the site over the centuries. The church is located near the castle and in previous times would have been part of a much larger complex of buildings in the vicinity of the castle. The present Church appears to be largely of fifteenth and possible early sixteenth century date. However it is likely that it replaced earlier Churches at or near the present site. In pre-Norman times, a Church dedicated to a local Saint, Fenivius, existed at Malahide.



South elevation of nave

The Church comprises a nave of approximately 17 x 7 metres and a chancel of approximately 9 x 5.7 metres divided by a shallow pointed chancel arch. There is a two-storey rectangular structure at the southeast corner of the chancel. The upper floor of this structure (which itself was probably sub-divided into two floors) is built on a stone barrel vault and accessed by an exterior stone stairs. The lower floor is approximately 430 mm below the present level of the chancel and is accessed directly from the chancel. The ground floor room presumably served as a sacristy and the upper structure above the barrel vault is typical of a fifteenth century “priest’s house” of which many examples exist.



East elevation

The north and south walls of the nave are decorated by stepped merlons in the Irish style. The east window is a plain pointed three light window in the perpendicular style. Interestingly the pointed window is inserted in a segmental-headed opening, which may imply that the east wall, at least, may date from the Romanesque period. The west window comprises a three-light cinquefoil fifteenth century window which was inserted in a larger opening, which has a shallow segmental head. The west wall is provided with stepped buttresses on either side of the window. There is a triple bellcote on the west wall. What appears to be a stepped access to the bellcote cantilevers from the east face of the west wall above the original roof level.



Detail of east window



The Church has directly opposing identical doors on the north and south walls of the nave. The doors have chamfered limestone architraves and hood mouldings. They are pointed and in fifteenth century style. Above the door on the southern side there is a grotesque mitred head and there is a stoup to one side. There are three windows on the south wall of the nave. One of these is a small opening at high level just beside the chancel arch. Of the others, one is a trefoil single light and the other a cusped trefoil double light. On the north side of the nave there is one trefoil single light window. The tracery is gone from all these windows.



Detail of west window – note damage to mullions

The chancel has one segmental-headed window on the south side between the chancel arch and the stairs access to the “priest’s house” and there are two segmental-headed window openings on the north side.





#### Entrance steps to priest's house

The “priest's house” has a segmental-headed window at first floor on the south wall as well as a small attic window and a small basement window providing light into the sacristy. There is also a small window on the west side and a segmental-headed window on the east side. There is a chimney on the south wall with a fireplace at first floor level.



Priest's house interior – south wall

The Church contains two graves of interest. The fifteenth century tomb of Maud Plunkett has a large flat stone with a recumbent carved female figure. There is also a gable-lid sarcophagus of probably seventeenth century date. There are also two sheela-nagigs carved in sandstone built into the east gable wall of the chancel.



### Maud's tomb

The graveyard wall on the north side is oval shaped and may be a remnant of a pre-Norman ecclesiastical site. The graveyard wall is a curious construction with roughly made merlons all along. It is probably a type of nineteenth century folly.

The north and south chancel walls were clearly extended upwards by the construction of battlements. There are string courses on the outside of both walls which roughly mark the line of the original eaves. Directly above the string courses there are a series of holes all along the walls, which are similar to holes made for fixing overhanging timber defensive platforms. The holes were made at the same time as the battlements were built and it is possible that the Church was a defensible structure at some stage.



Entrance door

Almost the entire structure has been re-pointed in cement mortar. Some historic lime plaster appears to remain on the chancel arch.



### 3.0 CONDITION

The structure, including the arches, window and door heads, walls, bell-cote and “priest’s house” is in good condition and has clearly been maintained and repaired in recent years. There are a number of areas where small amounts of vegetation are growing. Some of the ashlar architraves need to be re-pointed. The mullions of the west window are quite badly degraded and require repair. The flat walkways behind the battlements are vulnerable areas where water can collect and seep into the walls.



East elevation of west wall

Maud’s tomb has suffered damage over the years and one end has been supported by brickwork posts at each side. The sandstone sheela-na-gigs are badly eroded.

The floor of the “priest’s house” is leaking and this will lead to washing out of mortar from the supporting arch and ultimately could cause a structural problem.

The cement pointing of the entire structure is protecting it for the moment (and for the foreseeable future) but will eventually cause serious problems. Portland cement is an inappropriate material for

use in historic buildings. Cement pointing prevents masonry from drying out and this can eventually cause deterioration of the masonry in buildings of this type.

#### **4.0 VULNERABILITY**

The Church is in a stable condition at present and appears to be well looked after. Fairly small works will ensure its sustainability into the future. The level of vulnerability may be considered as 2 (on a scale of 1 to 5)



West elevation of east wall

#### **5.0 RECOMMENDED WORKS**

The building is generally in good condition and it has been maintained successfully in the past. Although it is comprehensively pointed in cement it is not recommended that this be removed at this time as the likelihood is that more harm than good would result. This is because the cement is strong and removing it from the joints would probably cause damage to the arrises of the stones. In due course the cement will begin to detach from the stones and to fall away. A good rule of thumb is that when this begins to happen it is time to remove the pointing and replace it with lime pointing.

Ministerial consent should be sought for the proposed works other than works of routine maintenance such as removing vegetation.

- 5.1 Vegetation on horizontal and vertical surfaces should be sprayed with an appropriate biocide such as 'Roundup' and removed. Although the vegetation is light, it should be cut away carefully from the wall. It should never be pulled as this can damage the mortar. When vegetation is killed off and removed the holes in the masonry should be filled in with lime mortar to prevent blown seeds entering the masonry.
- 5.2 The walkways behind the battlements should be examined and any holes which could permit water ingress into the body of the wall should be filled. Depending on the condition it may be appropriate to provide an impervious barrier on the horizontal surfaces. This could be done by providing a sloping plaster coat of lime based mortar on the surface. This should be made up of Hydraulic lime (NHL 5.0) with sand in the ratio 1 : 3.
- 5.3 The floor of the priest house should be waterproofed by installing an impervious covering. This could be done by removing vegetation and soil from the surface, laying a damp-proof membrane and finishing with a limecrete slab (ca 100mm thick). The slab should be to specialist design and should be reinforced with steel mesh. Other means could also be used.
- 5.4 The mullions of the west window tracery should be appropriately repaired by stone grafts, mortar repair or other methods. This work would have to be carried out by specialist masonry contractors.
- 5.5 The ashlar work should be generally examined and re-pointed as necessary. Re-pointing should be carried out using appropriate materials – the mortar should be of lime putty and sand.
- 5.6 Consideration should be given to repairing Maud's tomb by re-attaching pieces of masonry which have broken off and repairing cracks in the ashlar. This work would have to be carried out by stonemasons experienced in conservation work.



- 5.7 Casts should be taken of the two sheela-na-gigs and stored off site (or in the castle) and consideration should be given to methods of arresting the on-going weathering. For example, cement pointing in the immediate vicinity of the sculptures should be removed and replaced with lime pointing.
- 5.8 In the long term it may be necessary to consider removing the cement pointing and re-pointing in lime. To do this at present would do more harm than good.
- 5.9 A maintenance programme for the monument should be prepared and executed by the responsible authority.

---

DERMOT NOLAN BA BAI Eur Ing CEng MIEI

**CHARTERED ENGINEER AND  
HISTORIC BUILDINGS CONSULTANT**

## **APPENDIX**

### **DRAWINGS AND SITE LOCATION**

PRESTY HOUSE (FIRST FLOOR SHOWING)

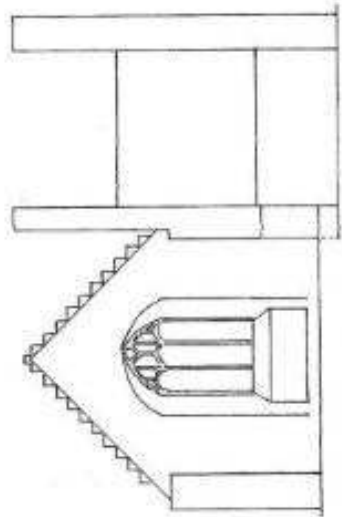
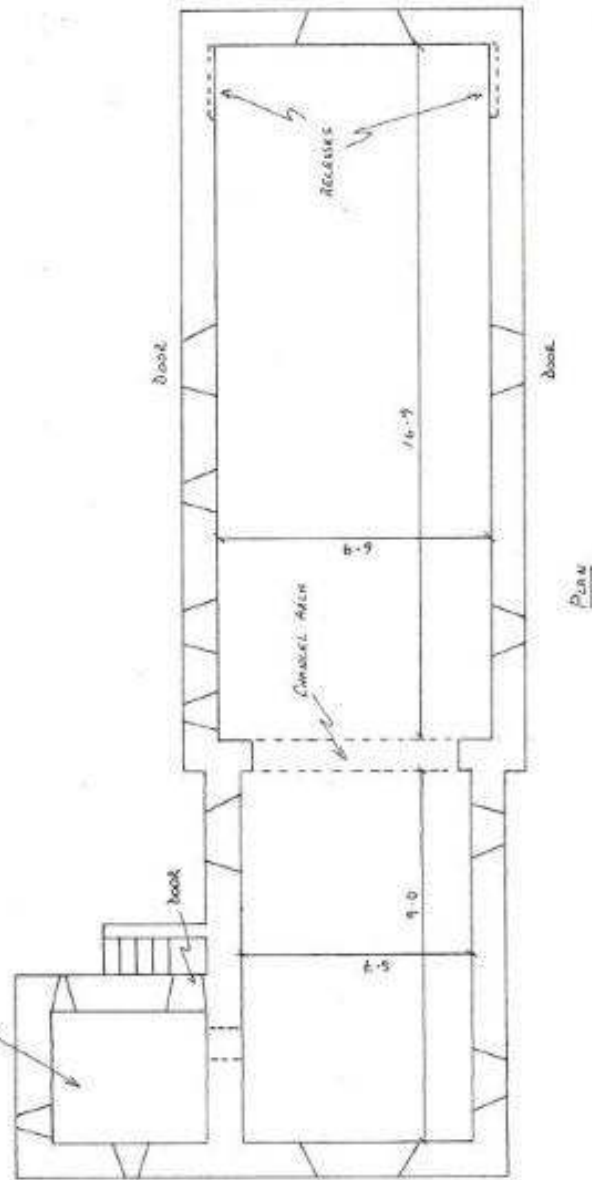

ELEVATION OF EAST WALL

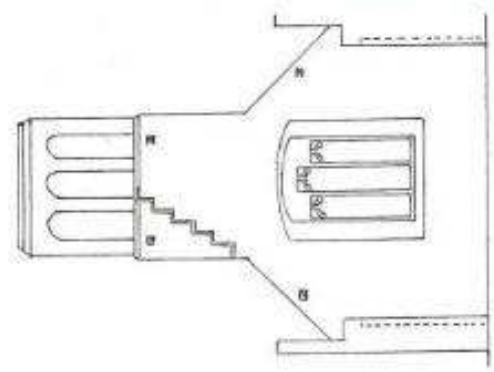

ELEVATION OF WEST WALL

CHURCH AT MALINDIG CASTLE

SCALE: 1/100

Nov 2011

Dennet Nolan & Associates  
 Architects, Engineers, Planners and Interiors Engineers

BERMOT NOLAN  
 RA 041 841 044 5000

Chapman - South Road, Boro Co. Wicklow  
 Tel: 01 852 26 2626 - Dublin 01 231 1000  
 Email: dennet@denetnolan.com denetnolan.com



**Comhairle Contae Fhine Gall**  
Fingal County Council

### Record of Protected Structures



RPS No. 384 Church of Malahide Castle, Demesne, Malahide, Co. Dublin



Scale 1:2000



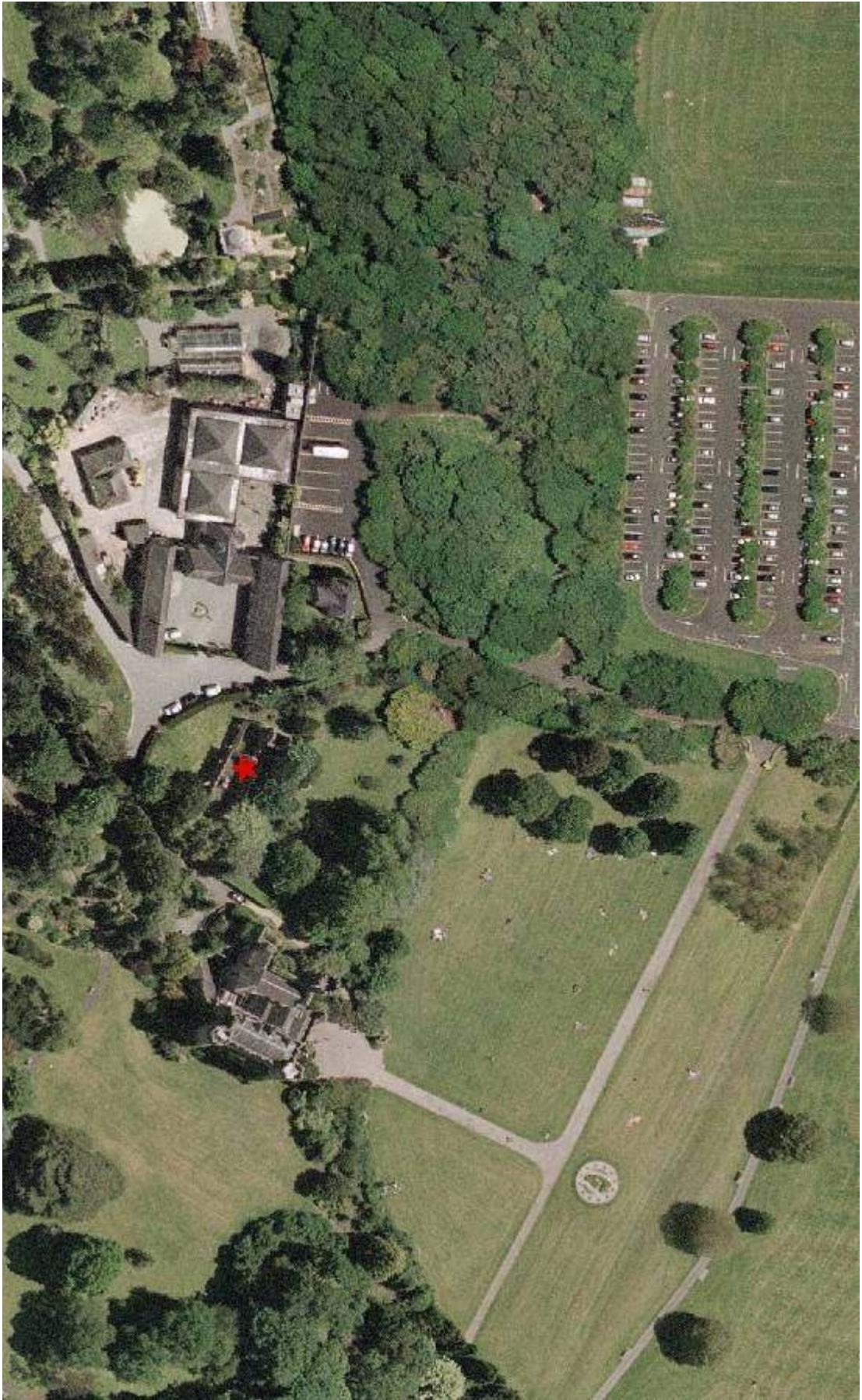



**STRUCTURAL ASSESSMENT  
OF  
ARCHAEOLOGICAL MONUMENTS  
IN  
FINGAL COUNTY COUNCIL OWNERHIP  
ST. MARNOCK'S CHURCH, PORTMARNOCK (No 6)**



(Setting (looking south-east))

**RECORD OF MONUMENTS AND PLACES (RMP) - DU015 - 007**

**RECORD OF PROTECTED STRUCTURES (RPS) - 478**

**Dermot Nolan & Associates  
Historic Buildings Consultants  
& Consulting Engineers  
'Claremount'  
Meath Road  
Bray  
Co. Wicklow  
Tel: 01-276 2626  
Email: [dnolanconservation@eircom.net](mailto:dnolanconservation@eircom.net)**

## 1.0 INTRODUCTION

The church, in the centre of a historic graveyard is located among sand dunes near the shoreline at Portmarnock. On the ca 1837 Ordnance Survey map it is shown as an apparently intact church with a laneway providing access from Strand Road. The ca 1900 map shows it as a “church in ruins” and there is no laneway. It seems quite possible that it was in use until perhaps the middle of the nineteenth century. There are now no identifiable features which might be evidence of this later use of the church.

St. Marnock’s Church was visited on the 4<sup>th</sup> November 2011. The weather was fine.



West gable wall, west face

## 2.0 DESCRIPTION

The structure was probably a parish Church dating from the 12<sup>th</sup> or 13<sup>th</sup> centuries and reportedly abandoned in the early 17<sup>th</sup> century. It is located in a graveyard quite close to the shoreline in Portmarnock. The remaining structure comprises the east and west gable walls and severely degraded north and south walls. It is a long, narrow building (19.0 x 5.4).

The east gable contained a large round-topped window which has been roughly filled in with masonry and retains its arch only in the inner face. Some lime plaster remains on the inner face of the wall. There is some evidence of a blocked up opening (probably a window) at the east end of the south wall. The west gable retains a small splayed, square topped window with a well-formed round

arch on the inside. It also retains most of its shaped barge stones and several copings on the south side. There is evidence of a belfry rising off the west gable. The cut stonework on this wall is of very high quality and is of significance as a fine example of 13<sup>th</sup> century craftsmanship.



West gable wall, east face

The west end of the south wall is ca 1.3 metres high and has been repointed relatively recently using cement mortar on the inner and outer faces. The interior comprises loose dry stone. This section of the wall may have been partially rebuilt. The rest of the south wall is very degraded with a collapsed area near the east end and all the mortar washed out. The east end of the wall is covered in ivy.





West gable – window detail

The north wall is in somewhat better condition but at the west end the mortar appears to be entirely washed out. There may have been some rebuilding in dry stone at this end. The east end is covered in ivy and retains some mortar.



East gable wall, east face

Several mounds of heaped stones exist within the church (see drawing) and these contain a number of cut stones. These stones were collected during a community clean up of the site. The chancel area is enclosed by a Victorian wrought and cast iron gated fence and contains at least one grave slab. The fence details are typical of the earlier Victorian period and this would indicate that its use as a place of worship may have ceased at or before this time.



### 3.0 CONDITION

The building is in very poor condition apart from the west gable. Recent work in reconstructing parts of the nave walls have helped to tidy the site and to make it more legible. The following are the main defects/problems.



South wall

- a) Much of the structure is now effectively dry stone as the mortar has been washed out.
- b) Vegetation at the east end of the building is causing further disintegration of the masonry.
- c) The lintel over the window ope in the west gable appears to be cracked and disintegrating.
- d) The site is entirely open with ready access for removal of stone. (This would be facilitated by the gathering of stone into identifiable heaps in several places).
- e) The west gable, which contains good examples of 13<sup>th</sup> century carved masonry has lost some stones at the south end and is gradually disintegrating.





South wall, west end

#### **4.0 VULNERABILITY**

The site is very vulnerable because it is in an open public area. The structure is suffering on-going degradation due to weathering and vegetation. Fallen stones can easily be moved or taken away. Urgent action under appropriate professional supervision is necessary.

On a vulnerability scale of 1-5 the church would be at 5.



North wall



North wall, west end

## 5.0 RECOMMENDED WORKS

The monument is in very poor and vulnerable condition and has not been

maintained in the past. The community has done some work and its involvement is welcome but it should seek professional advice prior to carrying out any works.



Ministerial consent would be required for all works to this monument.

- 5.1 All vegetation should be sprayed with biocide and removed. The vegetation should be carefully cut away at the face of the masonry. It should never be pulled as this could destabilise remaining mortar and masonry.
- 5.2 The broken lintel over the west window should be repaired by a mason experienced in conservation work.
- 5.3 When the vegetation is removed all the walls should be pointed. Remnants of the original mortar should be identified and analysed so that a matching mortar can be designed. A relatively weak lime putty mortar should be used in this case. In re-pointing it may be necessary to take out and re-set some stones. Masonry which has to be disturbed should be carefully recorded by photography and if possible by numbering and the records used in the re-building.
- 5.4 The wall tops should be provided with a protective mortar capping to prevent ingress of moisture into the tops of the walls. For this a hydraulic lime mortar should be used (NHL 5.0) in a mix of 1 : 3 with sand.
- 5.5 The fallen and heaped stones should be collected and stored in the chancel area. Any pieces of cut stone should be identified and recorded and consideration should be given to storing them off site. The iron gate within the chancel should be closed and locked to provide some minimum protection to the stored masonry.





Rubble pile – note cut stones

- 5.6 An information sign should be erected at the site to alert the public to the significance of the monument.
  
- 5.7 In this case consideration may have to be given to providing a secure fence around the monument.

---

DERMOT NOLAN BA BAI Eur Ing CEng MIEI

**CHARTERED ENGINEER AND  
HISTORIC BUILDINGS CONSULTANT**



## **APPENDIX A**

### **DRAWINGS AND SITE LOCATION**

NOTE: 0.7 INDICATES WALL TOP LEVEL ABOVE ADJACENT OUTSIDE GROUND

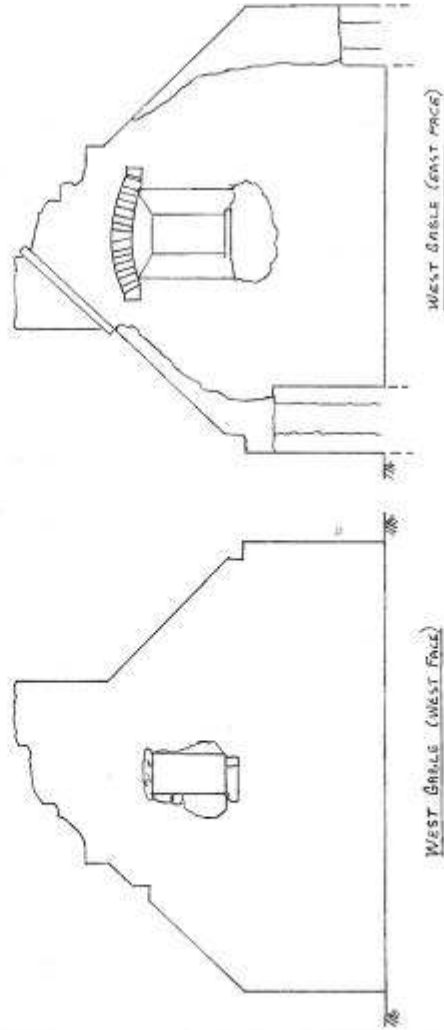
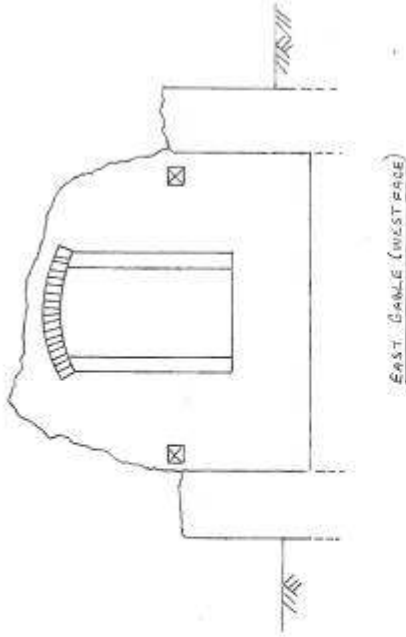
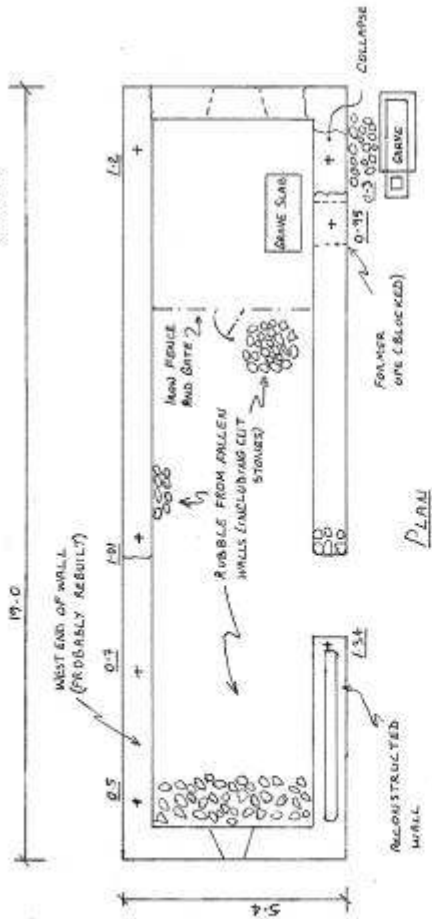

Saint Marys Church Portmarnock

Scale: 1:50

November 2011

DERMOT NOLAN & ASSOCIATES  
 Building Services and Consulting Engineers

DERMOT NOLAN  
 BA BA EIR Ing. Chd MIB

Chartered: Mech. Eng. Inst. E. Whilow  
 Tel: Fax: 01-206-3534 - Email: 805\_2011@dn.ie  
 Web: dnm.ie



**Comhairle Contae Fhine Gall**  
Fingal County Council

**Record of Protected Structures**



RPS No. 478 St. Marnock's Church (in ruins), off Strand Road, Portmarknock, Co. Dublin



Scale 1:2000







**STRUCTURAL ASSESSMENT  
OF  
ARCHAEOLOGICAL MONUMENTS  
IN  
FINGAL COUNTY COUNCIL OWNERSHIP**

**CHURCH AT ST. CATHERINE'S PARK, LEIXLIP (NO. 7)**



(south elevation)

**RECORD OF MONUMENTS AND PLACES (RMP) - DU017 - 003**

**RECORD OF PROTECTED STRUCTURES (RPS) - 716**

**Dermot Nolan & Associates  
Historic Buildings Consultants  
& Consulting Engineers  
'Claremount'  
Meath Road  
Bray  
Co. Wicklow  
Tel: 01-276 2626  
Email: [dnolanconservation@eircom.net](mailto:dnolanconservation@eircom.net)**

## 1.0 INTRODUCTION

The former church is now an isolated structure in a public park owned by the County Council. It is entirely engulfed in vegetation and trees and is in very poor condition generally.

The site was visited on the 3<sup>rd</sup> November 2011 and on the 23<sup>rd</sup> of February 2012. There was no access to the interior on the first visit. The weather was clear and bright on the first visit and cloudy and rainy on the second.

## 2.0 DESCRIPTION

This is an unusual structure about which not much is known. The plan layout of the building appears to have evolved over time. On Roque's map of County Dublin 1760, a rectangular structure is shown with a north-south orientation. The 1840 O.S. map shows an inverted T-shaped structure facing south and the ca. 1900 O.S. map shows a reversed L-shaped structure with the base facing west and having a porch on the west side. The present structure is almost square (8.8 x 8.0). The porch is gone and it appears that the leg of the 'L' facing north has been demolished.



West Elevation

The present single cell structure is gabled on the east and west sides. The eaves level is 6.0 metres. The west, east and north walls are entirely overgrown and obscured and it was not possible to examine them in detail. The building is fenced off and access to the interior was not possible.

The east window is a high pointed window with tracery. The details of the tracery were obscured by vegetation inside and outside the wall. The south wall has two large pointed windows framed in brickwork. There are a number of straight-line vertical joints below these windows which may be evidence of a previous disposition of openings on this wall.



View from the north side

Above the windows there are 3 – 4 courses of roughly laid bricks. It seems likely that the bricks were laid as part of a wall raising operation. Above the bricks the wall comprises roughly made limestone masonry. The eaves are finished in a string course of brick headers.

The entrance in the west wall is a pointed arch doorway with a cross timber at springing level. The barge is formed by four courses of brickwork. Some of the top course is missing due to disruption by vegetation.



View from the east side



The exterior of the rear (north) wall is entirely obscured by vegetation. There is a small hole in the wall which appears to be at the apex of the former blocked up door.



Detail of entrance door on the west side

The interiors of the walls were examined on the 23<sup>rd</sup> of February during the second visit to site. The walls generally retain a thick coating of lime plaster except at low level (up to ca 750 mm above ground level). This may be evidence of a former finish of timber wall paneling up to dado level. There are four niches or small recesses just above the entrance door (two at each side) which may have been support points for a former internal timber porch. There is clear evidence of a blocked up former door opening with a pointed arch at the east end of the north wall. The cills of the windows on the south elevation are badly degraded and bricks are missing from the arch soffits.



Detail of wall on south side – note construction joint

There are flues just inside both gables. At the west end the flue is an asbestos cement pipe. At the east end there is what appears to be a galvanized steel flue. There is a large tree growing inside the building. The interior ground level has been noticeably raised by fallen masonry, plaster and vegetation.





Detail of window head

### 3.0 CONDITION

This structure is in very poor condition primarily due to the action of rampant vegetation. The brickwork lining in the window surrounds, the eaves course and on the barges has been severely damaged. Mortar has been washed out in many places and there are local bulges in the walls which may be evidence of interior voiding. As noted above, the west, east and north walls are obscured by vegetation at present and it is possible that there are serious structural defects in these walls. The plaster on the outsides of the walls has been almost completely lost.



Detail of brick barge



View of the interior – note tree growth

#### 4.0 VULNERABILITY

The structure is very vulnerable and is decaying rapidly. It is a good example of the damage that can be inflicted on buildings by uncontrolled vegetation. The building appears to have been reasonably well secured against public access and does not seem to have suffered from vandalism. The removal of vegetation might, however, increase the risk that the building would become a target for vandals. On a scale of risk of 1-5 the building may be considered to be at level 5 and is likely to decay rapidly unless urgent action is taken.



Interior – note lime plaster on north wall

## 5.0 RECOMMENDED WORKS

It is not possible to specify in detail the necessary works until the vegetation has been removed. The first step should be to remove the surface vegetation while ensuring that the removal does not further destabilize the masonry.

The ground in the interior of the building should be investigated by an archaeologist to determine the original ground level and to find any remains of historic flooring. It may also be possible to retrieve fallen masonry and bricks which could be used in the repair of the structure.

All the works proposed would require Ministerial Consent and Planning Permission. The proposed investigation of the interior rubble, in particular would have to be carried out by a licensed archaeologist.

- 5.1 The vegetation affecting the building should be sprayed with biocide and removed. Trees which are growing in and beside the building should be cut down. Prior to removing the vegetation or carrying out any works, an ecologist experienced in assessing habitats in historic buildings should be consulted. An appropriate methodology should be agreed with the ecologist.

It may be necessary to dismantle sections of masonry to remove embedded roots. If this has to be done the relevant sections must be carefully recorded, numbered as far as possible before removal and measured stone by stone. The masonry should be reconstructed to match the original.

- 5.2 The wall tops should be protected by capping with lime mortar using an appropriate mix. The mix should be one part hydraulic lime (NHL 5.0) to three parts sand.
- 5.3 Loose and fallen bricks should be re-set and re-pointed on the barges and eaves and around the windows. Appropriate matching replacement bricks should be sourced and used to replace missing bricks. In particular the arches above the windows on the South wall require to be re-made. It will be necessary to provide temporary arched shutters to make the repairs to the window heads.
- 5.4 A section of brick masonry (approximately 1.0 square metres) above the right-hand window on the south elevation is bulging and in danger of collapse. It should be taken out and re-built.
- 5.5 The masonry cills of the two windows on the South elevation should be reconstructed using appropriate replacement stone. The source of the imported stone should be approved by the conservation consultant responsible for the works.

- 5.6 Other defects which become obvious once the vegetation is removed should be dealt with appropriately under the advice of a conservation consultant.
- 5.7 The entire building should be re-pointed. Particular attention should be paid to the door and window arches and surrounds and to the barges and eaves.
- 5.8 The details of the tracery in the east window should be recorded and any necessary repairs should be carried out under the supervision of a conservation consultant. The likely extent of the necessary repair cannot be determined until the vegetation is removed.
- 5.9 The exterior of the building should be plastered in an appropriate lime plaster. Samples of the original plaster should be tested and new plaster should match the original as far as possible.
- 5.10 The openings in the building should be secured to prevent public access. The most appropriate method of achieving this would be to install strong steel gratings.
- 5.11 In this case consideration may have to be given to providing a secure permanent fence around the building.
- 5.12 A maintenance programme should be prepared. The structure should be inspected once a year by a conservation professional and a condition report should be prepared with recommendations for maintenance works.

---

DERMOT NOLAN BA BAI Eur Ing Ceng MIEI

**CHARTERED ENGINEER AND  
HISTORIC BUILDINGS CONSULTANT**



## **APPENDIX**

### **DRAWINGS AND SITE LOCATION**

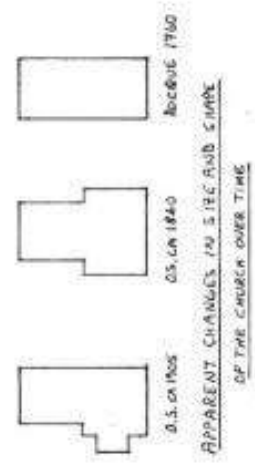
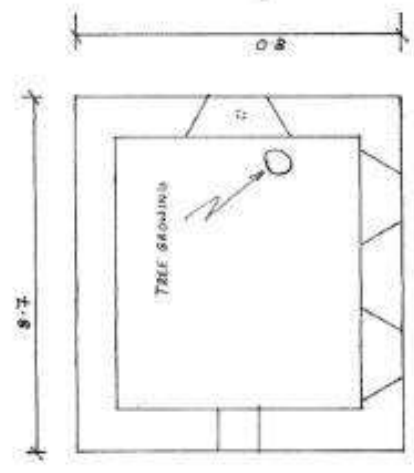
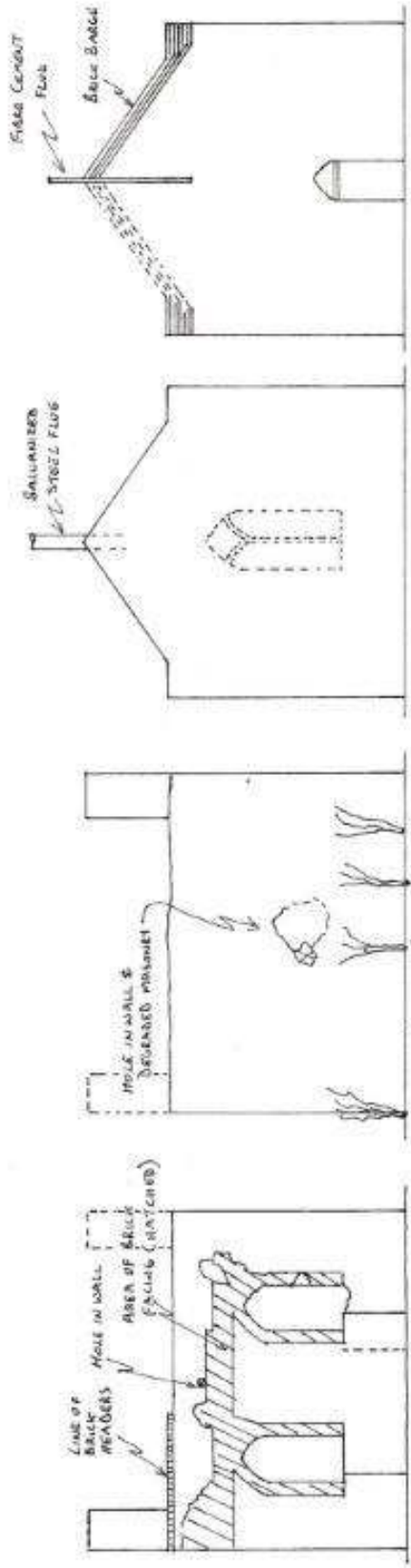

DERMOT NOLAN  
 84 343 Beech Street, Sydney NSW  
 (02) 9550 2700  
 www.dermotnolan.com.au

Dermot Nolan & Associates  
 Historic Building Conservation and Landmark Engineering

CHURCH IN SAINT CATHERINE'S PARK LEICESTER  
 SCALE: 1:100 Nov 2011

APPARENT CHANGES TO SITE AND CHURCH  
 OF THE CHURCH OVER TIME

PLAN

**Record of Protected Structures**



RPS No. 716 Church in ruins, St. Catherine's Park, Leixlip, Co. Dublin

**STRUCTURAL ASSESSMENT  
OF  
ARCHAEOLOGICAL MONUMENTS  
IN  
FINGAL COUNTY COUNCIL OWNERHIP  
MARTELLO TOWER, BALBRIGGAN (NO 8)**



**RECORD OF MONUMENTS AND PLACES (RMP) - DU002 - 004  
RECORD OF PROTECTED STRUCTURES (RPS)- 17**

**Dermot Nolan & Associates  
Historic Buildings Consultants  
& Consulting Engineers  
'Claremount'  
Meath Road  
Bray  
Co. Wicklow  
Tel: 01-276 2626  
Email: [dnolanconservation@eircom.net](mailto:dnolanconservation@eircom.net)**



## 1.0 INTRODUCTION

The Martello tower at Balbriggan is an important landmark in a prominent elevated position on the shoreline just outside the town. It is in a public open grassed area and is very visible and accessible. The interior is now entirely blocked off and there is no means of entering the building except possibly through the roof. The parapet was removed in the past reputedly to provide material to build houses in Balbriggan main street.

The tower was visited on the 5<sup>th</sup> November 2011. The weather was fine.

## 2.0 DESCRIPTION

The Balbriggan tower is a typical example of the towers built north of Dublin in 1804 – 1805. The provenance and details of the towers are well described in Paul M. Kerrigan's *"Castles and Fortifications in Ireland, 1485 – 1915"* (Cork 1995). The towers were basically gun platforms for coastal defense. Twelve were built north of Dublin and sixteen south of the city. These towers, including Balbriggan, were the subject of a study *"The Martello Towers of Dublin"* Bolton, Carey, Goodbody and Clabby (Dublin 2012). It was not possible to gain access to the tower interior for this project as the entrance is permanently blocked.



Tower former entrance

The towers built south of the city were of cut stone, whereas most of those built to the north, including Balbriggan, were of random rubble and were plastered (or 'harled').

Most of the tower is intact although the upper section has been entirely removed. The brackets which supported the defensive machicolation over the entrance door remain, although two of them are damaged. The upper section (which would have been about 1.0 m high) was removed to salvage the masonry. The entrance door at first floor level is blocked up with concrete blocks.



Elevation 2

The tower is circular with a diameter at the base of ca. 9.5 metres and a present height of ca. 6.7 m above the plinth. The plinth is 225 wider than the tower base and is 950mm high.



Elevation 3

The entrance faces inland, as was the practice for Martello construction. There are no other openings in the wall apart from six small ca. 350 x 350 openings with hooded heads, three at first floor level and three at high level. Two of the lower openings are filled. The two openings directly to the left of the entrance door are not filled and the upper one appears to have a steel or iron framing. It is likely that these openings served as air vents in the absence of windows. There is a small opening to the right of and below the entrance, which may be a defensive gun loop. There are no other features on the building. Apart from the removal of the parapet and the closure of the door opening, the exterior of the building has not been altered since it was built.



Elevation 4

### **3.0 CONDITION**

There is no evidence of subsidence and no structural cracking. The removal of the upper part of the structure may have left the tops of the walls unprotected. It would be necessary to gain access to the top of the wall to examine the condition. As noted above, the machicolation brackets have been damaged.

The lime plaster has been degraded and lost in some areas – particularly below the entrance. However most of it remains although it is patchy. The plaster appears to have protected the mortar in the masonry joints, which seems to have survived well where it is exposed. There are a number of small holes in the masonry (on the front and on the east side). There is no vegetation growing on the structure and no indication that the masonry is excessively wet, despite the removal of the top of the structure.





Elevation 5

#### 4.0 VULNERABILITY

The construction of the tower is so robust and massive that it has considerable resistance to decay. Decay of the main structure will occur slowly, even in adverse conditions. However, any timber or metal elements which might exist in the interior are likely to be destroyed by moisture due to the entire lack of ventilation.. The structure is not vulnerable in the short term. In the longer term it may be vulnerable, depending on the level of protection provided to the roof when the top was removed.



Elevation 6

If the structure has been vulnerable to water ingress through the roof, because of its massive construction, it would take a very long time to dry it out and make it usable. Its potential use value in the short term through, for example, opening it as a tourist attraction, may therefore be considered to be questionable pending examination of the interior.

On a vulnerability scale of 1 to 5, and on the evidence available from examining the exterior only, the building should be considered to be at 2 on the scale.

## **5.0 RECOMMENDED WORKS**

The gun platform (the roof) should be inspected as a matter of priority as this is the primary source of potential moisture ingress into the structure. A detailed inspection of this area would be a necessary condition for drafting effective repair and conservation proposals for the structure. Once the ingress of moisture into the structure has been stopped, a prolonged period of drying out will be required because of the great thickness of the walls.

In due course, the exterior may require to be re-plastered but that is not necessary at present.

Works to the building will require Ministerial Consent.



Detail of machicolation brackets

- 5.1 Access should be provided to the interior of the structure by breaking out the blocked up door opening. Access should also be provided to the roof.
- 5.2 When access is provided a detailed survey of the interior should be carried out and a plan for conservation should be prepared by a conservation professional. Particular attention should be paid to structural elements such as arches and lintels.
- 5.3 Original vents in the exterior wall (of which there appear to be four) should be reinstated.
- 5.4 As stated above the building will require a long period of drying out. Permanent ventilation measures will have to be carefully designed to ensure that they do not detract from the character of the building bearing in mind that these structures were always, by their nature and because of their function, very poorly ventilated. A planned programme of drying out will be required.
- 5.5 The roof should be covered in a water-proof membrane to prevent ingress of moisture into the interior.
- 5.6 Consideration should be given to re-building the parapet. Although there are strong conservation arguments against speculative reconstruction, in this case there is firm historical evidence available from other similar intact Martello towers.
- 5.7 The question of repairing the wall plaster should be addressed. This is not necessary at present for the sustainability of the structure however, a case may be made that to do so would improve the legibility of the building as a historic structure.

---

DERMOT NOLAN BA BAI Eur Ing CEng MIEI

**CHARTERED ENGINEER AND  
HISTORIC BUILDINGS CONSULTANT**

## **APPENDIX**

### **DRAWINGS AND SITE LOCATION**







**STRUCTURAL ASSESSMENT  
OF  
ARCHAEOLOGICAL MONUMENTS  
IN  
FINGAL COUNTY COUNCIL OWNERSHIP**

**MARTELLO TOWER, SKERRIES (NO. 9)**



(entrance front)

**RECORD OF MONUMENTS AND PLACES (RMP) - DU005 - 018**

**RECORD OF PROTECTED STRUCTURES (RPS) - 189**

**Dermot Nolan & Associates  
Historic Buildings Consultants  
& Consulting Engineers  
'Claremount'  
Meath Road  
Bray  
Co. Wicklow  
Tel: 01-276 2626  
Email: [dnolanconservation@eircom.net](mailto:dnolanconservation@eircom.net)**

## 1.0 INTRODUCTION

The Martello tower at Skerries is an important landmark in a very prominent elevated position near the shoreline. It is in a public open grassed area and is very visible and accessible. It is a touristic asset which was used in the past as a tea-rooms.

The exterior of the tower was inspected on the 5<sup>th</sup> November 2011. The weather was fine during the visit. Limited access was obtained to the interior during a further visit on the 23<sup>rd</sup> of February 2012.



Elevation 2

## 2.0 DESCRIPTION

The Skerries tower is a typical example of the towers built in the Dublin area in 1804 – 1805. The provenance and details of the towers are well described in Paul M. Kerrigan's *"Castles and Fortifications in Ireland, 1485 – 1915"* (Cork 1995). The towers were basically gun platforms for coastal defense. Twelve were built north of Dublin and sixteen south of the city. These towers, including Skerries, were the subject of a study *"The Martello Towers of Dublin"* Bolton, Carey, Goodbody and Clabby (Dublin 2012). It was possible to gain only partial access to the tower interior for this project.

The exterior of the tower is largely intact although various openings have been made in the walls over the years and subsequently filled in with blockwork (apart from one doorway at ground level which has a steel door).





Elevation 3

The tower is circular with a diameter (at the base) of 10.8 metres and a height of ca. 9.5 metres. The tower sits on a plinth which is 300mm wider all round. The walls are constructed from coursed cut stone blocks. The entrance doorway is at first floor level facing inland with a defensive machicolation supported on corbels above. There are four filled in small openings with projecting stones above (see detail 'X' on the accompanying drawing) which appear to be original. The purpose of these is not known. There are two door insertions, one to the left of the original entrance which is now filled in. The other has a steel door and is on the north side. There are four blocked up openings, three at first floor level and one at ground floor. These openings are 1.9 x 1.35 and appear to have been windows and may be evidence of former residential use.



Elevation 4

There is trace evidence of a building built up against the tower on the south (entrance front) side. This was a tea rooms which operated during the mid twentieth century. There is also a possible gun loop at ground floor level below the original entrance.



Elevation 5

The tower walls are approximately 2.5 metres thick at ground level. The ground floor is a concrete slab. There is an intermediate timber floor at first floor level and the gun platform is supported on a large masonry arch. The interior has been much altered. A section of the wall 1.9 metres wide was removed up to the top of the first floor to make the present entrance opening and a wide window over. The window opening was subsequently blocked up with concrete blockwork. A similar opening was made in the exterior wall directly opposite the present door to form windows at ground and first floor levels. An earlier door opening (1.22 wide by 2.6 high) appears to have been made on the south side near the original door opening which was at first floor level. These openings were subsequently blocked up with concrete blockwork.

A further large window opening (1.35 high x 1.9 wide ) was made at first floor level and this was also filled in with block work.

The interior wall has two ground level recesses to the left of the entrance, at least one of which appears to have been a fire place. There is a remnant brickwork partition also to the left of the entrance which carries a corner fire place. The access to the first floor is by a concrete spiral staircase directly opposite the entrance. The floor to floor height is 2.75 metres.

The first floor comprises 150 x 75 boards on 225 x 90 joists at 310 centres. Some of the joists are supported on trimmers and there



Elevation 6

are also two steel beams carrying the floor. The floor is supported in several places by by 'Acrow' props. There are remnants of timber paneling on the ceiling soffit. The first floor is in a dangerous condition and it was not possible to walk on it to examine the upper parts of the building.

Access to the gun platform appears to be via an original spiral stone staircase just beside the original entrance door.

There are remnants of original plaster on the interior walls at ground and first floor levels and on the soffit of the gun platform arch.



Elevation 7

### 3.0 CONDITION

On the exterior there is no evidence of subsidence and no structural cracking was noted. However the brackets supporting the machicolation appear to have been damaged, probably when a structure was erected against the tower. There is extensive loss of mortar from the masonry joints. In some areas, the mortar has been replaced by inappropriate cement pointing, which may result in moisture retention in the masonry. At high level there is moss growing in the joints which is evidence of dampness in the wall. At low-level, mortar has been completely washed out of the joints. There appears to be virtually no ventilation of the interior.



Detail of blocked up former openings

The interior of the building is very damp. The floors and walls are palpably wet and there are 'stalactites' suspended from all the soffits above the first floor. The timber elements in the building are very badly affected by wet rot which makes it unsafe to access the first floor as noted above. The first floor steel beams are badly corroded.





Detail of machicolation with concrete infilling

Generally, where openings and demolitions were carried out after the structure was built, proper lintels or arches were not installed and this has introduced potential structural weakness in parts of the walls. To date the structure has not been seriously affected by this.

The condition of the wall tops and gun platform is not known as there was no access to the roof of the structure. The excessive dampness within the building is evidence that substantial re-pointing and waterproofing is required at roof level.



Evidence of water ingress at high level

#### **4.0 VULNERABILITY**

The construction of the tower is so robust and massive that it has great resistance to decay and decay will occur slowly, even in extremely adverse conditions. Because of its form of construction – cut stone and masonry arches – the building will survive for a considerable time even after all the mortar is washed out of the masonry joints. The structure is not vulnerable in the short term. However because of its massive construction it would take a very long time to dry it out and make it usable. Its potential use value in the short term as, for example, a tourist attraction, may therefore be considered to be questionable.

On a scale of risk (of 1 – 5) to its sustainability the building may be considered to be at level 3.



Evidence of mortar washout at low level

#### **5.0 RECOMMENDED WORKS**

The gun platform and the upper sections of the walls should be inspected as a matter of priority as these are the primary sources of moisture ingress into the structure. A detailed inspection of these areas would be a necessary condition for drafting effective repair and conservation proposals for the structure. The proposals below, although they need to be carried out, will not have a substantial impact on the condition of the structure unless the roof level repairs are carried out at the same time.

Once the ingress of moisture into the structure has been stopped, a prolonged period of drying out will be required because of the great thickness of the walls.

Works to the building apart from 5.1 below will require Ministerial Consent.



Interior – ground floor – note propping of floor over

The structure of this monument is quite sound and it is a fine example of a Martello tower in the county area and in a popular tourist location. If funds could be made available to fully repair and conserve the building, and to make it publicly accessible, it could become a popular tourist site.



Ground floor – note rotted timber floor over

- 5.1 The remnants of modern interventions on the exterior should be removed. These include flashings and brick inserts along the line where the 'tea house' roof abutted the building. Concrete infilling between the brackets which support the machicolation over the original front door should also be removed. A redundant plastic 'ESB' box and ceramic electric cable insulators should be removed from the exterior wall surface.



- 5.2 The first priority in this case is to provide access to the roof and to carry out waterproofing works to stop the ingress of moisture through the roof which is obviously on-going. The necessary details cannot be elaborated until access is provided.
- 5.3 Original vents in the exterior wall (of which there appear to be Four) should be reinstated. In a number of places individual ashlar stones have been removed in the past and the spaces have been infilled with concrete or cement. These fillings should be removed and replaced with matching ashlar. There are fourteen of these infills which need to be replaced.
- 5.4 The two door and five window openings which have been made in the wall during the twentieth century should be opened by removing the modern blockwork filling and resealed in limestone ashlar to match the original. The original door opening at first floor level should be reopened and an appropriate cast iron door should be installed. A stair access from ground level should be provided.



First floor interior – note lime ‘stalactites’



- 5.5 The entire exterior should be treated with biocide and re-pointed.
- 5.6 When access to the first floor is provided the head details of each opening in the wall should be carefully examined by an appropriately experienced engineer. Where necessary lintels should be provided.
- 5.7 The entire first floor timber structure should be taken down. The timbers should be examined and original timbers which are re-usable should be set aside. A new first floor should be installed using as much of the historic timber as possible.
- 5.8 The interior should be treated with biocide and re-pointed. Where original plaster remains it should be left in place.
- 5.9 As stated above the building will require a long period of drying out. Permanent ventilation measures will have to be carefully designed to ensure that they do not detract from the character of the building bearing in mind that these structures were always, by their nature and because of their function, very poorly ventilated. A planned programme of drying out will be required.

---

DERMOT NOLAN BA BAI Eur Ing Ceng MIEI

**CHARTERED ENGINEER AND  
HISTORIC BUILDINGS CONSULTANT**

## **APPENDIX**

### **DRAWINGS AND SITE LOCATION**

MARTELLO TOWER SKERRIES

SCALE: 1/100

NOVEMBER 2011

*Dermot Nolan & Associates*  
 Historic Building Consultants and Consulting Engineers

**DERMOT NOLAN**  
 RIBA Chartered Architect

11 Chequer, North Road, Bray, Co. Wicklow  
 Tel: 051 852 5252 - Mobile: 087-3313158  
 Email: [dermot@dnac.ie](mailto:dermot@dnac.ie) www.dnac.ie

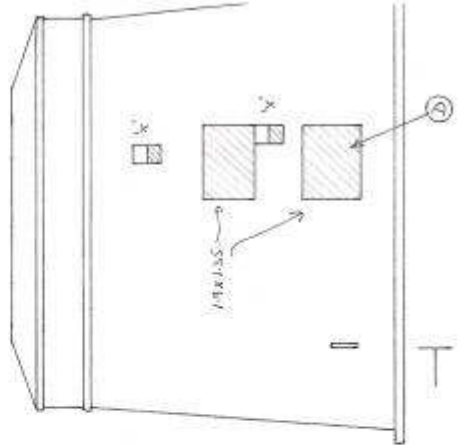
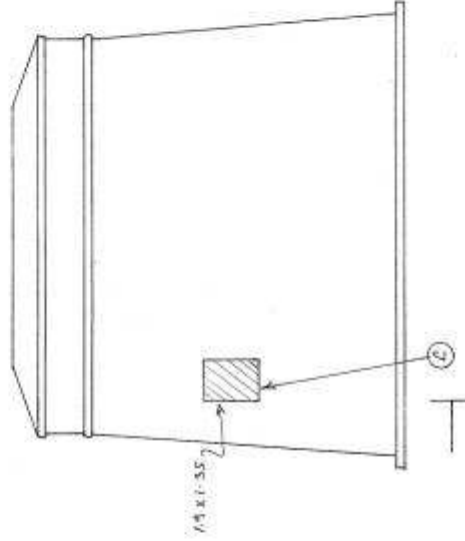
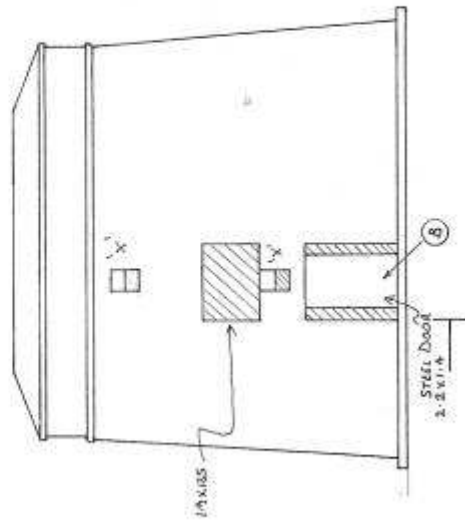
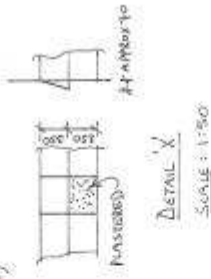
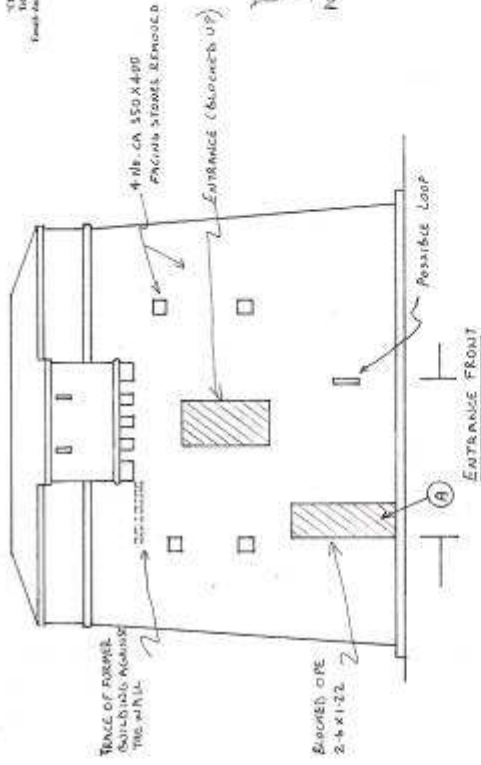
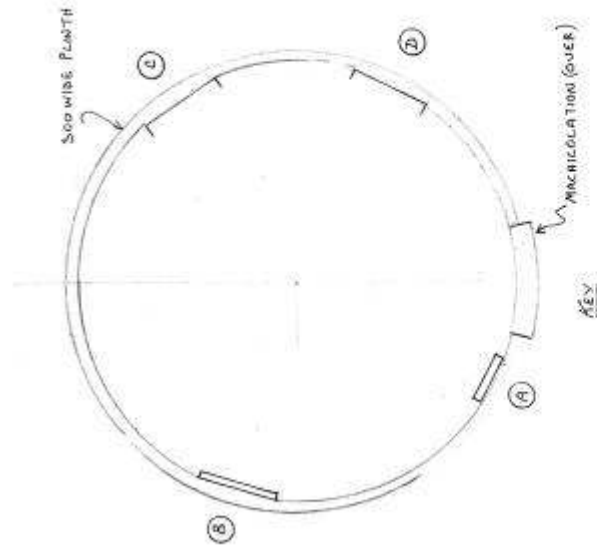

**Record of Protected Structures**



RPS No. 189 Martello Tower, Red Island, Skerries, Co. Dublin



**STRUCTURAL ASSESSMENT  
OF  
ARCHAEOLOGICAL MONUMENTS  
IN  
FINGAL COUNTY COUNCIL OWNERHIP  
HOLMPATRICK CHURCH TOWER, SKERRIES (No 10)**



(General view from the north-east)

**RECORD OF MONUMENTS AND PLACES (RMP) - DU005 - 031**

**RECORD OF PROTECTED STRUCTURES (RPS) - 225**

**Dermot Nolan & Associates  
Historic Buildings Consultants  
& Consulting Engineers  
'Claremount'  
Meath Road  
Bray  
Co. Wicklow  
Tel: 01-276 2626  
Email: [dnolanconservation@eircom.net](mailto:dnolanconservation@eircom.net)**

## 1.0 INTRODUCTION

The tower appears on the ca 1837 Ordnance Survey map as the west tower of a church which was demolished during the nineteenth century. This church was replaced by the present church directly to the north which is shown on the ca 1900 O S map. The previous church had been demolished at that stage leaving the tower as a free standing structure. The style of the tower with its very finely carved ashlar embellishments is distinctively late Georgian. The date of construction is not known with certitude although one source gives a date of 1819. It is possible that the tower was an addition to an older relatively unsophisticated parish church which fell into such disrepair that it had to be replaced during the nineteenth century. The site appears to be very old and several features are shown (rather indistinctly) directly south of the tower on the ca 1837 map which apparently were archaeological monuments.



South elevation

Holmpatrick Church Tower was visited on the 5<sup>th</sup> November, 2011. The weather was fine and sunny.

## 2.0 DESCRIPTION

The tower is centrally located in a cemetery. The tower is a local landmark located at a high point in the cemetery overlooking the town. It is now entirely disused and inaccessible (the doorway is permanently blocked up).



North elevation

The tower is square (4.6 m. side) almost symmetrical and ca. 16 metres high. It was finished in lime harling with very finely carved limestone ashlar string courses and window surrounds. The entrance door is round-headed with chamfered reveal. At first floor level, there are square window openings on each side except the east (which abutted the Church). The window frames were casement shaped and two of these survive. There are string courses above and below these windows. The belfry level has high, pointed louvre openings on all four sides. The timber louvre on the north side is largely intact.

The parapet is framed by square ashlar blocks on each corner which rise off a string course. The merlons which make up the parapet are capped at varying levels providing a lively and attractive elevation. The corner blocks support hexagonal pyramid-shaped pinnacles topped by crockets, one of which is missing. There is a shield-shaped plaque with no inscription at low level on the north side of the tower. The trace of the former Church roof can be seen on the east side. The roof of the tower was apparently pitched with lead gutters all around.



East elevation

### **3.0 CONDITION**

The roof has entirely collapsed and it is likely that the interior timber work such as bell supports, floors and ladders has also collapsed. The lead gutters can be seen through the louvre openings hanging from the walls as their timber supports have completely decayed. Some vegetation is growing in the parapets and there is some damage to merlons. The mortar joints in the parapet ashlar blocks appear to be completely washed out. One crocket (at the north-west corner) has fallen and one other is leaning. The timber framing is gone from three of the louvre openings and one of the windows. Some of the exterior plaster has been washed off the walls.

Apart from the above, the tower is in good structural condition with no evidence of cracking or subsidence.

### **4.0 VULNERABILITY**

The tower is not immediately vulnerable to serious structural distress although it will continue to deteriorate from the top down if no remedial action is taken. Its inaccessibility adds to its



vulnerability because at present it would be impossible to carry out routine maintenance.

On a vulnerability scale of 1 to 5 the tower should be considered to be at level 3.



West elevation - upper



West elevation - lower

## 5.0 RECOMMENDED WORKS

The recommended works are repairs and measures to protect the structure. No invasive work is proposed. Ministerial consent would not be required.

- 5.1 Reopen the blocked door ope to permit access for inspection and maintenance. The opening should be re-sealed with a lockable steel grating.



Parapet detail – east elevation

- 5.2 The parapet requires to be completely refurbished and repaired. This will require scaffolding the building on all sides and providing access to the inside faces of the parapet walls. Loose remnant timbers and lead flashings should be removed. The vegetation growing from the parapet should be sprayed with biocide and removed. Damaged and dislodged stones should be re-set. The parapets should be re-pointed and flashed. The pointing should be carried out using hydraulic lime (NHL 3.5) and fine sand in a 1 : 2.5 mix. All of the work should be specified by an experienced conservation professional.



Louvre – north elevation

- 5.3 The roof should be replaced with a slated roof and a structure designed to match the original using remaining evidence of the original roof and examination of still existing roofs on structures of similar date. An appropriate rainwater disposal system should be installed to protect the interior of the building. As there is no evidence of a former system on the exterior it will probably involve interior rainwater pipes.
- 5.4 The perimeters of all window and louvre openings should be sealed with silicon and flashings should be provided to cills and other vulnerable areas.
- 5.5 Spray and remove vegetation on the South wall. Spraying should use 'Round up' or similar appropriate biocide. After spraying the vegetation should be carefully removed by cutting as close to the masonry as possible. Vegetation should never be pulled away from the masonry as this could damage pointing or dislodge stones.
- 5.6 All ashlar elements (window surrounds etc) should be pointed as specified in 5.2 above.



Detail behind parapet (note unsupported lead gutter lining)



Detail of window frame and wall plaque on north wall



- 5.7 Consideration should be given to repairing the lime harling on the exterior of the walls. While this is not a conservation priority it would assist in re-establishing the legibility of the structure as a heritage artifact.

---

DERMOT NOLAN BA BAI Eur Ing CEng MIEI

**CHARTERED ENGINEER AND  
HISTORIC BUILDINGS CONSULTANT**

## **APPENDIX**

### **DRAWINGS AND SITE LOCATION**

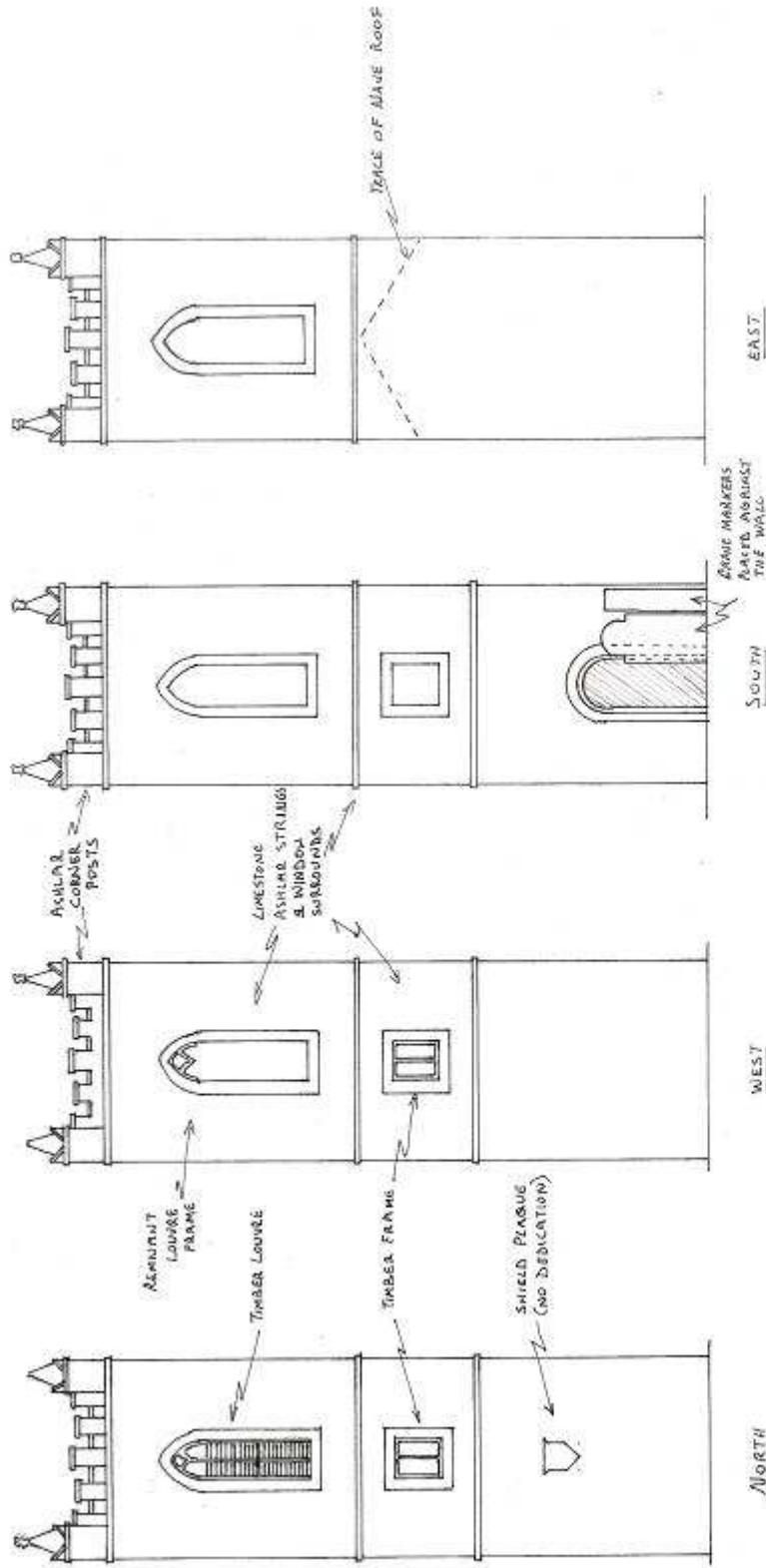

ELEVATIONS

NOTE:  
 1. THE ROOF HAS COLLAPSED  
 2. THE TOWER WAS PLASTERED.

HOLY PATRICK CHURCH SKERRIES

SCALE: 1:100

NOVEMBER 2011

*Dermot Nolan & Associates*  
 Historic Building Consultants and Consulting Engineers

DERMOT NOLAN  
 RA 043 Bar No C092 MBEI

100, Greenway, North Road, Drogheda, Co. Wick  
 Tel: 011 259 2400, Fax: 011 259 2401, Email: info@dnol.com  
 Email: dno@dnol.com, www: dnol.com





**STRUCTURAL ASSESSMENT  
OF  
ARCHAEOLOGICAL MONUMENTS  
IN  
FINGAL COUNTY COUNCIL OWNERHIP  
RUSH TOWER HOUSE (NO 11)**



(Setting of the monument in parkland)

**RECORD OF MONUMENTS AND PLACES (RMP) - DU008 - 003**

**RECORD OF PROTECTED STRUCTURES (RPS) - 254**

**Dermot Nolan & Associates  
Historic Buildings Consultants  
& Consulting Engineers  
'Claremount'  
Meath Road  
Bray  
Co. Wicklow  
Tel: 01-276 2626  
Email: [dnolanconservation@eircom.net](mailto:dnolanconservation@eircom.net)**

## 1.0 INTRODUCTION

The tower house has been in a severely decayed condition for a long time. Both the ca 1837 and ca 1900 Ordnance Survey maps show the outline of the structure but neither identifies it even though the historic O S maps were generally quite meticulous in recording ancient monuments. Only the undercroft and first floor exist and it is possible that the rest of the building was dismantled at some time in the past for salvage of the stones.

The Rush tower house was visited on the 5<sup>th</sup> November 2011. The weather was fine and clear.



East elevation

## 2.0 DESCRIPTION

This monument comprises the remains (up to first floor level) of a fifteenth century tower house. The footprint is a rectangle 5.0 x 7.4 internal with 1.1 m thick walls, a corner tower at the north-east and a stair tower at the south-west. There is a barrel vault roof which at present is entirely overgrown with grass and other vegetation. The undercroft has small splayed windows in the north and south walls, an entrance at the foot of the spiral stairs and a doorway into the small tower at the northeast.

There are two small recesses in the north wall and one in the south wall. There is a fireplace on the east wall with a mural chimney which now finishes at first floor level. The northeast tower has a splayed window on the north side and a rectangular window on the south side. It has a corbelled roof with a triangle-shaped opening at the centre. The tower walls are 700mm thick.



North elevation

The stair tower was entered from the north side and the spiral steps are still quite complete up to first floor level. The west wall of the staircase has been re-built as a masonry wall with a cavity. There are ten risers of ca. 225mm in the spiral.



West elevation

Much of the south and east walls are covered in ivy and the masonry could not be clearly seen.

The castle is located in an open field and is surrounded by a steel fence which has been breached by vandals. The site is adjacent to a



large housing estate. There is a great deal of rubble (including bottles, cans,



South elevation (west side)

etc.) in the undercroft and the walls are defaced by graffiti. The enclosed area inside the steel fence is much overgrown but it is clear that it contains a great deal of fallen masonry from the monument.



Entrance to spiral stair

### 3.0 CONDITION

Viewed from the inside, the walls and roof of the undercroft are generally in quite good condition although very damp. There is an



area of collapsed wall facing ca. 800 x 300 on the west wall and the masonry around the chimney has disintegrated. The lintel over the door into the undercroft is badly cracked. There was formerly a pointed architrave at the door but



Spiral stair from above

one half of the arch is gone. The lintel over the window on the north side of the north-east tower is cracked. The ivy growth on the exterior is quite heavy and undoubtedly is harming the masonry. The grass and soil on top of the monument may be protecting the masonry to some extent (by absorbing rainfall rather than letting it percolate through the masonry of the barrel vault), but in the long term it is likely to cause damage.



Entrance to undercroft (note damaged arch)

#### 4.0 VULNERABILITY

The monument has been neglected and there appears to be a lack of on-going maintenance. The extensive vegetation growing on the outside and the collapse of wall facings on the inside will lead to gradual degradation



Undercroft – view from entrance

of the walls. Cracked lintels, in particular over the entrance door, could cause the collapse of sections of masonry. There is free access to the public and vandalism, lighting of fires, etc. appears to be on-going. In present conditions, the monument is quite vulnerable and it urgently requires repair and protection.

On a scale of vulnerability of 1 to 5 the monument should be considered as highly vulnerable ie at level 5. This is primarily because of its lack of protection against on-going vandalism.



Undercroft – collapsed fireplace

## 5.0 RECOMMENDED WORKS

All of the works proposed below (apart from removal of vegetation and securing the site) would require Ministerial Consent.

- 5.1 The vegetation on the outside should be sprayed with biocide and removed. Vegetation should be carefully cut away after spraying and should not be pulled out as this could dislodge mortar and stones.



North-east tower – corbelled first floor

- 5.2 The vegetation within the steel fence area should be sprayed and the area should be examined for stones fallen from the building or associated with it. This should be done by an archaeologist and the findings recorded. Depending on the results of the archaeological survey, a decision should be taken on an appropriate landscaping finish around the monument. It may be appropriate to have some type of hard landscaping. In any event, vegetation should be removed from close proximity to the monument.
- 5.3 The grass on top of the monument should be sprayed and removed. When the masonry is being inspected, consideration should be given to providing a waterproof cover to protect the barrel vault. This might comprise a damp-proof membrane protected by a reinforced limecrete or concrete slab.
- 5.4 The cracked lintels over the entrance door and over the north window in the north-east tower should be repaired. This



work should be executed by a mason experienced in conservation. The work may involve stitching with stainless steel pins.



View from first floor towards the north-east

- 5.5 The cracked lintels over the entrance door and over the north window in the north-east tower should be repaired. This work should be executed by a mason experienced in conservation. The work may involve stitching with stainless steel pins.



First floor east side – note truncated chimney and north-east tower



- 5.6 The damaged interior masonry in the undercroft on the west wall and at the chimney on the east wall should be rebuilt by a mason experienced in conservation work. Fallen stones in-situ and stone recovered from around the site should be used in rebuilding.
- 5.7 When the vegetation is removed the exterior of the structure should be examined and be re-pointed as necessary. The re-pointing should be done with hydraulic lime (NHL 3.5) and sand in a mix of 1 : 3.
- 5.8 The remnants of steel balustrade on the stairs should be removed.
- 5.9 The protective fence should be repaired and made sufficiently strong to resist vandalism. This should be done as a short-term strategy. Hopefully in the future it will be possible to devise an appropriate strategy for public access to the monument.
- 5.10 The graffiti on the stonework should be cleaned off by steam cleaning or other appropriate method.
- 5.11 An information sign should be erected on the site to alert the public to the significance of the monument.

---

DERMOT NOLAN BA BAI Eur Ing CEng MIEI

**CHARTERED ENGINEER AND  
HISTORIC BUILDINGS CONSULTANT**

## **APPENDIX**

### **DRAWINGS AND SITE LOCATION**

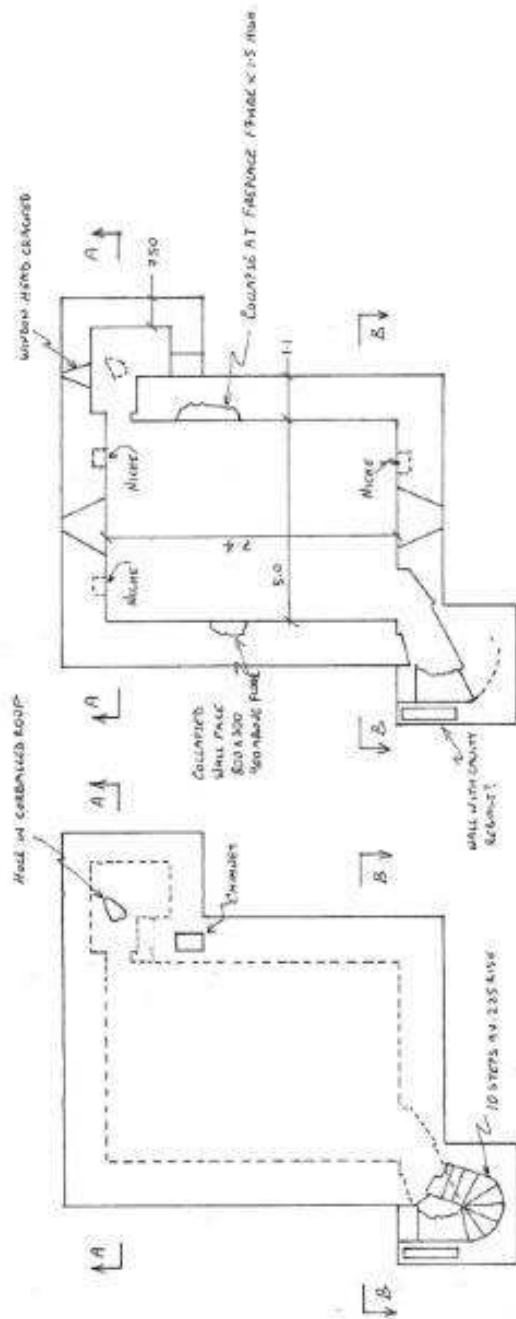

PLAN OF UNDERCROFT

PLAN AT FIRST FLOOR

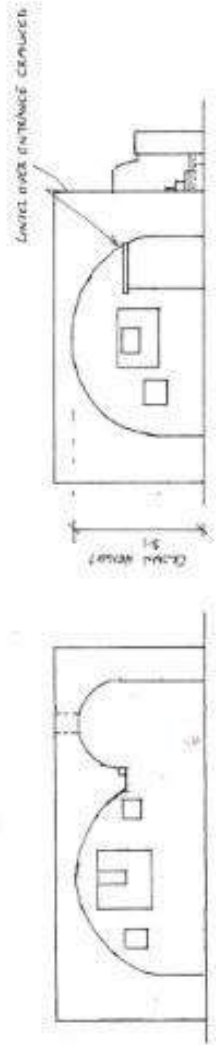

SECTION A-A

SECTION B-B

TOWER HOUSE RUIN AT RUSH

SCALE: 1:100

NOV 2011

**Derwent Nolas & Associates**  
 Historic Buildings, Townscapes and Consulting Engineers  
**DERWENT NOLAN**  
 85 BALFORD WAY, CHORLEY  
 CHORLEY, BLACKBURN, LANCASHIRE, BB9 7JG  
 01257 353535  
 www.derwentnolan.co.uk





**STRUCTURAL ASSESSMENT  
OF  
ARCHAEOLOGICAL MONUMENTS  
IN  
FINGAL COUNTY COUNCIL OWNERHIP  
CHURCH AT RUSH DEMESNE (No 12)**



(General view from the south-west)

**RECORD OF MONUMENTS AND PLACES (RMP) - DU008 - 003  
RECORD OF PROTECTED STRUCTURES (RPS) - 254**

**Dermot Nolan & Associates  
Historic Buildings Consultants  
& Consulting Engineers  
'Claremount'  
Meath Road  
Bray  
Co. Wicklow  
Tel: 01-276 2626  
Email: [dnolanconservation@eircom.net](mailto:dnolanconservation@eircom.net)**

## 1.0 INTRODUCTION

This structure is a medieval parish Church which appears to date from ca. 15<sup>th</sup> century. It may have been built on the site of an earlier church. It is located at the highest point of a graveyard in a formerly rural area although there is now a modern housing estate nearby. It is close to Rush Demesne castle, a former tower house and was probably associated with it. It is adjacent to a small river and to a historic well site (Saint Catherine's).



East gable

The Church was inspected on the 5<sup>th</sup> November 2011. The weather was clear and fine.

## 2.0 DESCRIPTION

The Church is a simple rectangle ca. 16.0 metres x 7.0 metres. It is not quite symmetrical – the west gable appears to be slightly wider than the east and the east window appears to be slightly off centre on the gable wall.

The east window is pointed and has a pointed hood moulding above. There is a cross-shaped roof vent above the east window and some vegetation growing on top of the east gable wall. The top of the east window has remnants of tracery. The west window is a narrow pointed lancet with a wide interior splay. The top of the west wall is entirely obscured by vegetation and it is not clear

whether there is a belcote. The south and north walls vary in height from ca 2.0 to ca 3.0 metres. The



West gable

south wall has two small square headed windows at the east end, both of which have been blocked up. There is a pointed doorway on the south wall which provides the present access through a steel gate. There is a similar doorway on the north wall which is blocked up.

The entire structure has been re-pointed in cement mortar. Remnants of lime plaster remains on the inside of the west gable above the window. There are a number of grave slabs and grave markers in the interior and a tomb with an iron fence surround.





North Wall

There are graves dug very close to the walls on all sides. There is a plaque on the north wall commemorating local cholera victims who died during the Famine.



View along north wall (note bulging)

### 3.0 CONDITION

The vegetation on both gables may be causing damage – particularly on the west gable but this can only be determined by removing it. There is evidence of a small area of wash out of mortar at the base of the north wall. There is quite extensive cracking on the west gable wall which is probably due to subsidence caused by the proximity of graves. The north wall has a wavy profile with bulges which is probably historic and not of concern.





Mortar washout at the base of the north wall

Apart from these matters, the structure is quite solid and is protected for the moment by the heavy cement pointing.

#### **4.0 VULNERABILITY**

The problem of subsidence on the west gable is potentially serious in the medium term. In the long term the cement pointing may cause damage to the masonry but is not a matter of immediate concern. The vegetation, particularly on the west gable will cause disintegration of the masonry if it is not removed.

On a scale of vulnerability of 1 to 5 the church may be considered to be at level 2-3. The most urgent matter is the subsidence at the west gable.



Cracking on east gable (note graves directly beside the wall)

## 5.0 RECOMMENDED WORKS

The works recommended below (apart from vegetation removal) will require Ministerial approval.

- 5.1 The vegetation on both gables should be sprayed with biocide and removed. After spraying the vegetation should be cut back close to the masonry and carefully removed. Vegetation should never be pulled from a masonry wall as this could damage pointing and dislodge stones.
- 5.2 The area of mortar wash-out at the base of the north wall (ca 6.0 metre long) should be re-pointed. It should be pointed using hydraulic lime (NHL 5.0) and sand in a mix of 1 : 3.



West gable interior (note plaster remnants)

- 5.3 The cracking in the west gable should be monitored over ca two years by attaching tell-tales to the wall in selected locations. Should it become clear that the movement in the wall is on-going, measures will have to be taken to address it. This would involve digging trial pits to examine the soil under the wall. This will be a difficult operation because graves have been dug directly against the outside of the wall. It might be necessary to work from inside the wall. All excavation work will have to be supervised by a licenced archaeologist. The investigation work should be supervised by a conservation engineer. Should remedial works be considered necessary some form of underpinning may be required.
- 5.4 Generally all reasonable measures should be taken to try to prevent digging of graves directly against the walls of the structure. This is a common practice and has frequently resulted in undermining, and sometimes causing the collapse of, the walls of historic structures in graveyards.
- 5.5 In the long term it may be necessary to consider removing the cement pointing and re-pointing in lime. To do this at present would do more harm than good.





Tracery remnants at east window.

- 5.6 Where vegetation is removed from the walls there may be some loss of mortar and some holes in the masonry. These areas will require to be re-pointed. The mix specified in 5.2 above should be used.



Famine memorial plaque

---

DERMOT NOLAN BA BAI Eur Ing CEng MIEI

**CHARTERED ENGINEER AND  
HISTORIC BUILDINGS CONSULTANT**



## **APPENDIX**

### **DRAWINGS AND SITE LOCATION**

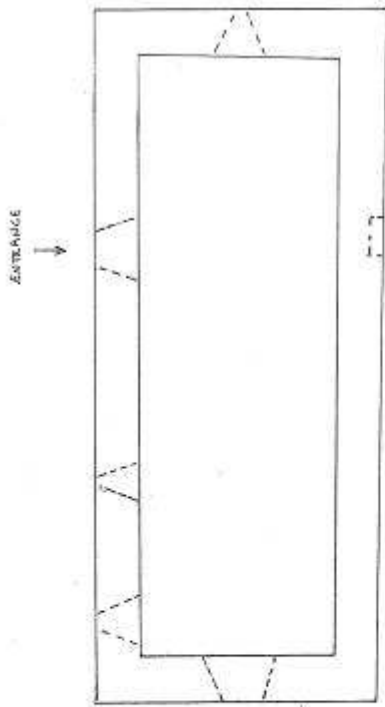

PLAN (NOTE PLAIN SHAPE IS ASYMMETRIC)

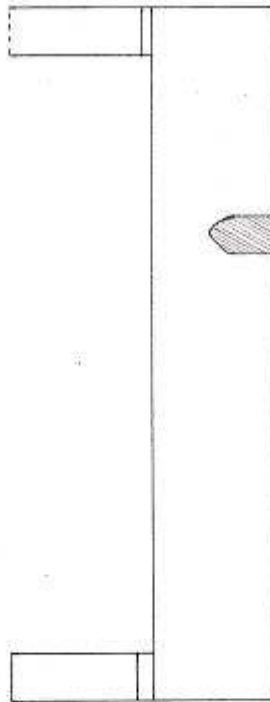

NORTH ELEVATION

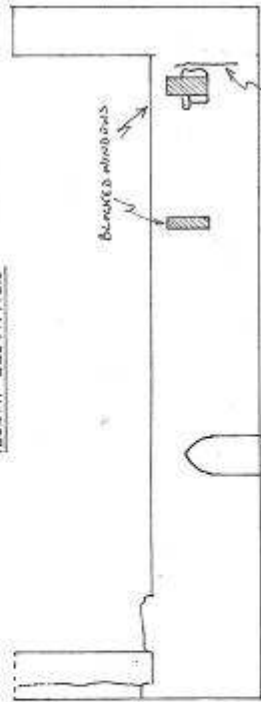

SOUTH ELEVATION

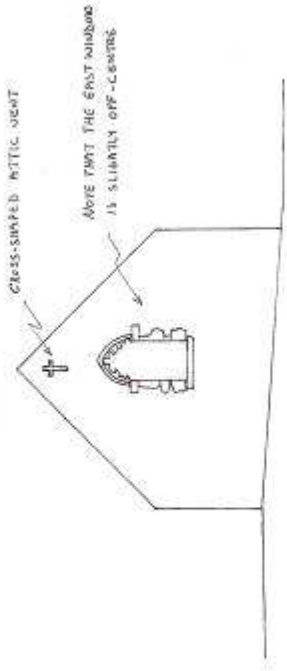

EAST ELEVATION

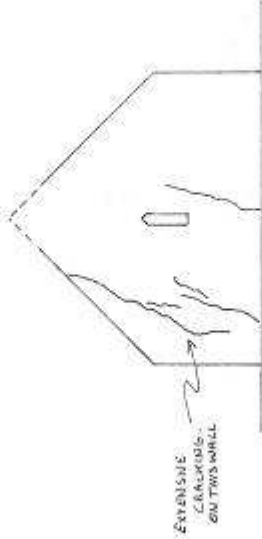

WEST ELEVATION

- More:
1. THE TOP OF THE WEST GABLE IS OBTAINED BY VEGETATION. IT IS NOT KNOWN WHETHER THERE IS A BELFRY.
  2. BRACKS HAVE BEEN BUILT VERY CLOSE TO THE WALLS AND THIS MAY HAVE CAUSED SQUELISHES AT WEST GABLE.
  3. THE ENTIRE STRUCTURE IS POINTED IN SAND AND CEMENT.
  4. ACCESS TO THE INTERIOR IS PROVIDED BY STEPS GRANTING.

**Dermot Nolan & Associates**  
 Historic Building Consultants and Consulting Engineers  
 DERMOT NOLAN  
 BA RATHFRY COLLEGE 1982  
 "Chartered" North West, New, Co. Wicklow  
 Tel: 046 228 2024 - Mobile: 087 501199  
 Email: dno@dermotnolan.ie www.dermotnolan.ie

CHURCH AT RUSH DEMENSE

SCALE: 1:100

NOVEMBER 2011



**STRUCTURAL ASSESSMENT  
OF  
ARCHAEOLOGICAL MONUMENTS  
IN  
FINGAL COUNTY COUNCIL OWNERHIP  
KNOCKSEDAN BRIDGE (NO 13)**

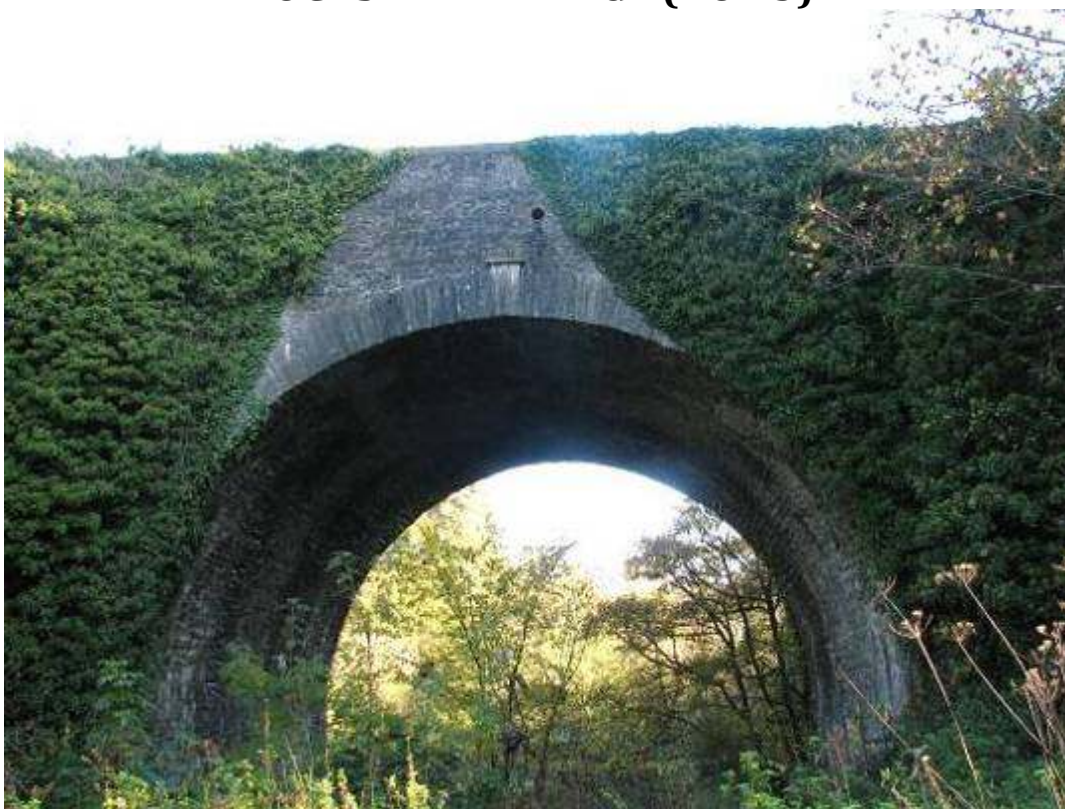

(Upstream elevation)

**RECORD OF MONUMENTS AND PLACES (RMP) - DU011 - 028**

**RECORD OF PROTECTED STRUCTURES (RPS) - 367**

**Dermot Nolan & Associates  
Historic Buildings Consultants  
& Consulting Engineers  
'Claremount'  
Meath Road  
Bray  
Co. Wicklow  
Tel: 01-276 2626  
Email: [dnolanconservation@eircom.net](mailto:dnolanconservation@eircom.net)**



## 1.0 INTRODUCTION

The bridge is a major early nineteenth century construction. It is significant by virtue of its size, spanning a very wide and deep valley. It is also significant as a result of its connection to the 1916 revolution. It was the meeting place of activists from the area and a plaque on the parapet records this event.

The bridge was visited on the 4<sup>th</sup> and 6<sup>th</sup> November 2011. The weather was mild during the visits.



General view from the south

## 2.0 DESCRIPTION

The bridge was previously reported on in 2007 by Kelly and Cogan – “Conservation Report and Impact Statement” – and in 2008 by John Cronin and Atkins – “Built Heritage and Ecological Inventory of Bridges Volume 2”. These documents are available and provide detailed descriptions of the bridge. This report therefore gives only an outline description.



Downstream elevation

The bridge is an extremely significant example of early nineteenth century civil engineering. It crosses a wide and deep valley over the River Ward west of Swords. As a result, it is a very substantial structure which is about 12 metres above the river and the bridge parapets are ca. 170 metres long.

The bridge is single arched with a span of ca. 12 metres. Because of the height of the bridge, large buttresses support the abutments on both sides. The upstream buttresses are triangular in plan (presumably to act as cut-waters in the event of flooding) and the downstream, rectangular. The construction is of random rubble with long thin cut stone voussoirs forming the arch with prominent keystones on each elevation. Through walkways on both sides constrict the river channel and protect the feet of the abutments. These have been underpinned and repaired with concrete in the past. Much of the bridge soffit has been re-pointed in cement mortar.

The raised roadway on either side of the bridge is supported by continuous double or triple leaf retaining walls infilled with earth or stone.

The buttresses and the valley in general, are much overgrown and provide an important habitat. The protection of habitat has to be taken into account in considering remedial works to the bridge.





Detail of parapet

### 3.0 CONDITION

It is difficult to form an opinion on the condition of the bridge and its ancillary elements because so much of it is entirely hidden by vegetation. For example, the buttresses are so densely covered that it was not possible to measure them accurately, let alone assess the condition of their surfaces. There are a number of defects:



Collision damaged wall south-east of the bridge

- g) A section of wall circa 7 metres long has been knocked out (presumably by vehicle collision) on the east side, south of the bridge.
- h) There is evidence of undermining of the walkway on the north abutment of the bridge.
- i) There appears to be at least one hole in the bridge soffit which could permit washing out of mortar from above the arch.
- j) There are small lime 'stalactites' on the bridge soffit – particularly at the arch edges which indicate that washing out of lime from the arch interior has occurred.
- k) The road drainage holes in the bridge parapets discharge directly over the bridge masonry and have damaged the pointing on the spandrels.
- l) The very heavy vegetation growing in and on the masonry is very likely to be causing serious and on-going problems of destroying mortar, dislodging stones and blocking weepholes.



Buttress at south-east corner

#### 4.0 VULNERABILITY

Because of its size and height, defects in the bridge could easily be missed and could have serious consequences. The pervasive vegetation makes early identification of problems difficult. The bridge appears to be well constructed and has survived for ca. 200 years with no evidence of serious problems. There is no visible evidence of any large-scale repairs in the past. However, it is very important that the bridge be carefully monitored on an on-going



basis. It is possible, for example, that weep-holes clearly visible in a ca. 1890 photograph, have been blocked and this could lead to a build up of water and water pressure within the structure.



Buttress at south-west corner

On a scale of vulnerability of 1 to 5 the bridge should be considered to be at the top end of the scale (5) because of its size and scale and the potentially catastrophic results of failure.



Underpinning at north abutment

## 5.0 RECOMMENDED WORKS

Repair works above the bridge ie to the road surface and parapet walls would generally not require Ministerial Consent . Removal of vegetation would not require consent. Any interventions in the masonry structure below the road level would require Consent.

- 5.1 The surface water discharges should be spouted to throw the discharge off the masonry.
- 5.2 The road surface on the bridge should be checked to ensure that rainwater is not seeping into the bridge arch.



Lime 'stalactites' on bridge soffit

- 5.3 The soffit of the bridge should be carefully inspected and any holes should be filled in with an appropriate mortar. The mortar should be lime-based and must be carefully designed by an experienced conservation engineer.
- 5.4 The masonry faces of the river channel along the walkways should be pointed and repaired as necessary. This may involve some underpinning or other concrete repairs. The works should be planned and supervised by a conservation engineer experienced in bridge works. The mortar design for re-setting masonry and for re-pointing will have to be carefully considered because of the vulnerability of the structure to flooding and mortar washout.
- 5.5 Vegetation should be removed from the faces of the buttresses, the spandrel and areas of the retaining walls to permit inspection. This should be done in consultation with an ecologist to ensure protection of habitats as far as

possible and could possibly be localised to selected critical areas. Because of the size of the structure and the extent of the vegetation this will be a major operation which will have to be carefully planned. The vegetation should be sprayed with biocide, possibly several times before it is removed. Removal of vegetation should be by cutting it as close as possible to the masonry. It should never be pulled as this could damage the mortar and dislodge stones.

It may be necessary to remove areas of masonry to expose and remove large root systems. Should this be necessary the existing masonry should be carefully recorded by photography prior to removal and the record should be used in rebuilding to copy the original.



Possible hole in bridge soffit

- 5.6 When the vegetation is removed the condition of the masonry should be carefully assessed by an experienced conservation engineer. In particular dislodgement of stones, the condition of the pointing and the efficacy of weepholes should be examined.



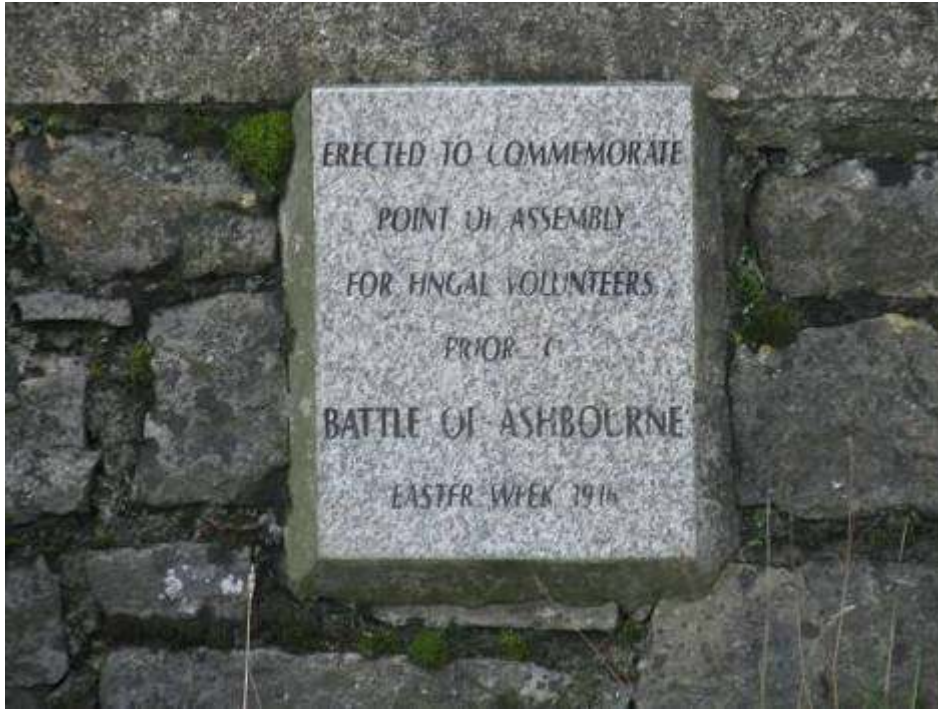

Commemorative plaque

- 5.7 It is strongly recommended that a planned regime of regular inspections should be put in place on a long-term basis. These inspections should be under the control of the Roads section of the County Council in conjunction with the Conservation section and should be carried out by an experienced conservation engineer.

---

DERMOT NOLAN BA BAI Eur Ing CEng MIEI

**CHARTERED ENGINEER AND  
HISTORIC BUILDINGS CONSULTANT**



## **APPENDIX**

### **DRAWINGS AND SITE LOCATION**

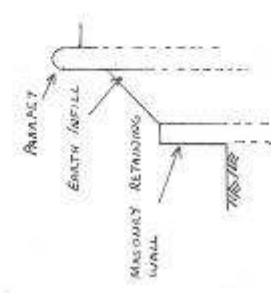
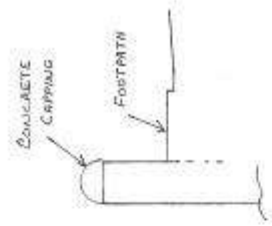
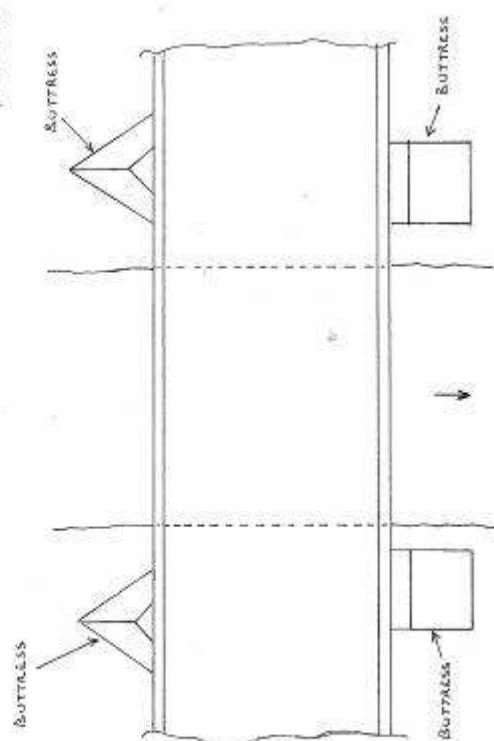
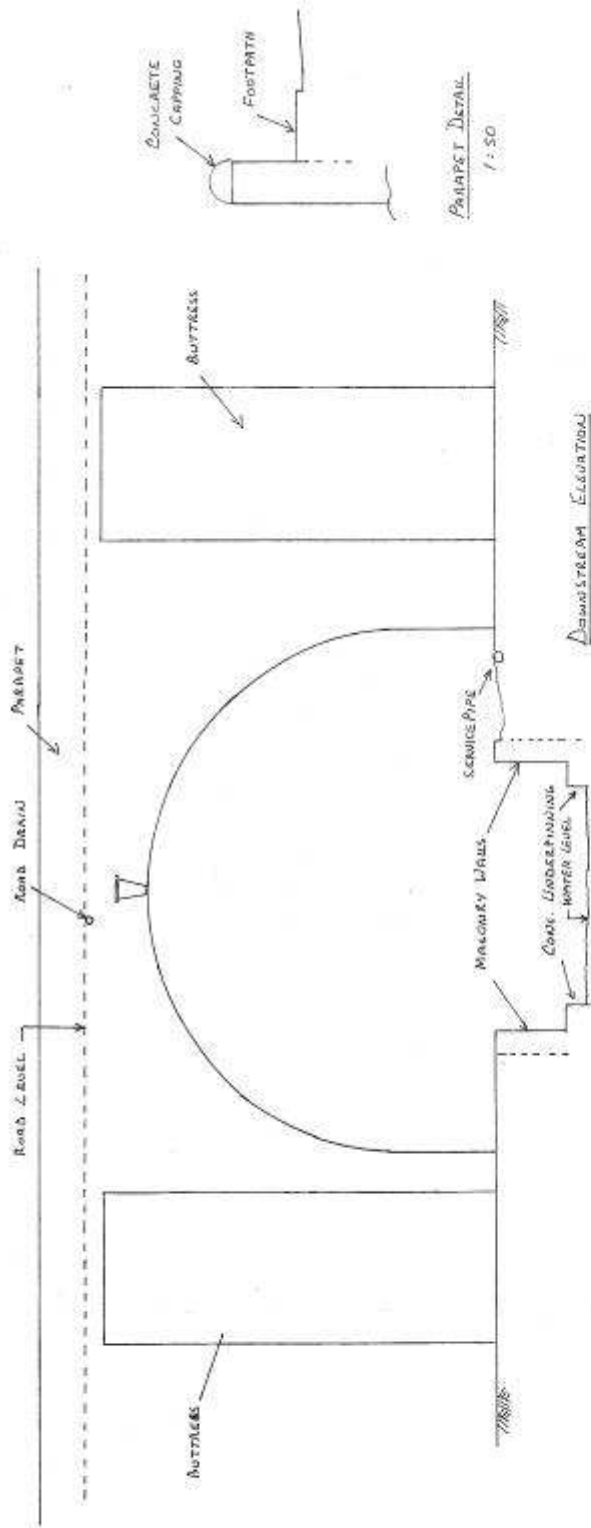

PLAN SHOWING BUTTRESSES  
1:200

TYPICAL DETAIL OF RETAINING WALL  
1:100

PARAPET DETAIL  
1:50

*Dermot Nolan & Associates*  
 Structural, Building, Construction and Consulting Engineers  
 11, Crossway, North Road, Ballydoon, Wicklow  
 Co. Wick, Ireland. Tel: 053 912 1111  
 Email: d.nolan@dnac.ie www.dnac.ie

DERMOT NOLAN  
 BA BA1 For Eng (C) Eng (M) Eng

11th Floor, 11, Crossway, North Road, Ballydoon, Wicklow  
 Co. Wick, Ireland. Tel: 053 912 1111  
 Email: d.nolan@dnac.ie www.dnac.ie

11th Floor, 11, Crossway, North Road, Ballydoon, Wicklow  
 Co. Wick, Ireland. Tel: 053 912 1111  
 Email: d.nolan@dnac.ie www.dnac.ie

KNOCKSEDAN BRIDGE SWARDS

11th Floor, 11, Crossway, North Road, Ballydoon, Wicklow  
 Co. Wick, Ireland. Tel: 053 912 1111  
 Email: d.nolan@dnac.ie www.dnac.ie

**NO SITE LOCATION AVAILABLE FOR KNOCKSEDAN BRIDGE**

**STRUCTURAL ASSESSMENT  
OF  
ARCHAEOLOGICAL MONUMENTS  
IN  
FINGAL COUNTY COUNCIL OWNERHIP  
ST. CATHERINE'S CHURCH, PORTRANE (NO 14)**



(The setting of the church in the village)

**RECORD OF MONUMENTS AND PLACES (RMP) - DU008 - 031**

**RECORD OF PROTECTED STRUCTURES (RPS) - 522**

**Dermot Nolan & Associates  
Historic Buildings Consultants  
& Consulting Engineers  
'Claremount'  
Meath Road  
Bray  
Co. Wicklow  
Tel: 01-276 2626  
Email: [dnolanconservation@eircom.net](mailto:dnolanconservation@eircom.net)**



## 1.0 INTRODUCTION

This medieval Church is located in a graveyard in the centre of Portrane village. It is noted as having belonged to the nunnery of Grace Dieu prior to suppression in 1540. It is located close to the coast and near to Stella's tower.

Saint Catherine's Church was visited on the 4<sup>th</sup> November 2011. The weather was fine and clear.



South wall

## 2.0 DESCRIPTION

The structure now comprises a single rectangular space approximately 5.4 x 15.4 (interior dimensions) with a west tower (3.5 x 2.4 internal). The south wall has been reduced to eaves level and the north wall to ca. 1.0 m high at the west end and ca. 1.8 m at the east end. The structure was clearly built in three phases. The east end has 600mm thick walls and the west has 1.0 m thick walls. It is not clear which was built first or when either part was built.

At a later stage the west wall was removed and the tower was apparently built as a stand-alone structure, the small gaps at either side were then filled in with a 300mm thick infill wall. The tower walls are 1.0 m thick. There are remnants of substantial buttresses at both ends of the east gable – probable evidence of subsidence in the past. The masonry in all parts of the structure is quite rudimentary and the exterior wall would have been plastered in the past.

On the south wall there is a round-headed entrance door at the west end and two square headed windows with chamfered reveals. No features are



North wall

identifiable on the north wall, the west end of which appears to have been re-built.



View from the east end of the church

The tower has stepped battlements in the Irish style. The entrance from the Church into the tower is an opening with a quite crudely made pointed arch. There is a small opening above the arch. The

purpose of this opening is unclear. There is a large segmental headed opening at first floor on the south wall, which looks as if it may have been an elevated doorway at some stage. (It is possible that the tower was lived in after the Church was unroofed and this would explain the existence of the small



The west elevation

window on the east wall, which otherwise would have opened into the Church roof space). There is a pointed window at ground floor level on the west wall which has a simple tracery dividing it into two lights. There are segmental-headed windows on each elevation at belfry level below a simple string course. Remnants of historic plaster remain on the Church tower walls and window reveals. There are two medieval carved heads at high level on the tower – one on the north wall and one on the south at the gutter string course . They are badly eroded and difficult to make out.

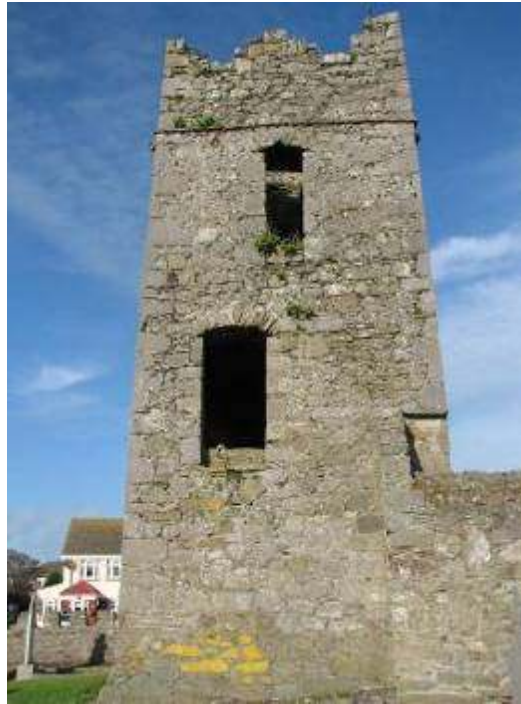

South elevation of the tower



North-west view of the tower

### 3.0 CONDITION

The battlements on the tower have suffered from considerable mortar wash out and require to be re-pointed. Some areas of the exterior of the tower walls on all sides require to be re-pointed. The interior of the tower requires re-pointing of the arches generally and repair to the walls locally – in particular, to the west and east



walls at first floor level where removal of the floor has created a situation of potential instability by leaving voids in the walls.



Window opening in the south wall

The north and south walls of the Church have generally been pointed inside and out with cement and this has protected them for the moment. However the tops of these walls do not appear to have been repaired. There is quite heavy ivy growth on the north wall and this is probably causing damage. There is also some vegetation in places on the tower walls.



The interior looking east

The Church and graveyard appear to be used by persons for various leisure activities. The interior of the Church was quite untidy with

cans and bottles lying on the ground. Several grave markers appeared to be broken or to have been moved.



The tower interior west wall

#### **4.0 VULNERABILITY**

The Church is generally in reasonably sound condition. The most vulnerable areas are the upper level, and parts of the interior of the tower. If these are repaired the structure will be secured for at least the medium term.



Tower interior east wall

In due course, the extensive cement pointing on the Church walls will create problems but for the moment, it is protecting the fabric. Vandalism and disorderly behavior (climbing on walls, etc.) may be a threat to this structure. Its open location in the centre of the village makes it accessible and difficult to protect. The north wall is too low to prevent access into the Church even if the door were blocked.

On a scale of vulnerability of 1 to 5 the church may be considered to be at level 3-4

## **5.0 RECOMMENDED WORKS**

The works to the building proposed below (other than removal of vegetation) would require prior Ministerial Consent.

- 5.1 The building should be sprayed with biocide and the vegetation should be removed. The vegetation should be carefully cut away after spraying. It should never be pulled as this could damage mortar and dislodge stones.
- 5.2 The battlements on the tower should be re-pointed as well as areas on the exteriors of the walls where mortar has been washed out. The mix used should be hydraulic lime (NHL 5.0) to sand in the proportion 1 : 3.



Window on the south wall

- 5.3 Damaged masonry above the window on the west wall and the arch on the east wall of the tower interior ground floor should be filled and re-pointed. The other window heads in the tower should be re-pointed as necessary. The mix used should be as in 5.2 above.
- 5.4 The tops of the Church north and south walls should be cleaned off, repaired and covered with a curved or sloped lime plaster coping to prevent water ingress into the walls. The mix should be as in 5.2 above.
- 5.5 Consideration should be given in due course to removing cement pointing on the Church walls. However this would not be advisable at present because the removal would do more harm than good.
- 5.6 An information sign should be erected at the site to inform the public of the significance of the monument.
- 5.7 The whole question of public access needs to be addressed creatively in this case. As it is probably not realistic or desirable to block public access, a strategy providing public information and involving the village population as far as possible in the protection and maintenance of the monument may be the best approach.

---

DERMOT NOLAN BA BAI Eur Ing CEng MIEI

**CHARTERED ENGINEER AND  
HISTORIC BUILDINGS CONSULTANT**



## **APPENDIX**

### **DRAWINGS AND SITE LOCATION**





Comhairle Contae Fhine Gall  
Fingal County Council

**Record of Protected Structures**



RPS No. 225 Tower of Church, Holmpatrick, Skerries, Co. Dublin

Scale 1:1000





**STRUCTURAL ASSESSMENT  
OF  
ARCHAEOLOGICAL MONUMENTS  
IN  
FINGAL COUNTY COUNCIL OWNERHIP  
SAINT FINTAN'S CHURCH, CARRICKBRACK (NO 15)**



(View of the church from the north-east)

**RECORD OF MONUMENTS AND PLACES (RMP) - DU015 - 031**

**RECORD OF PROTECTED STRUCTURES (RPS) - 575**

**Dermot Nolan & Associates  
Historic Buildings Consultants  
& Consulting Engineers  
'Claremount'  
Meath Road  
Bray  
Co. Wicklow  
Tel: 01-276 2626  
Email: [dnolanconservation@eircom.net](mailto:dnolanconservation@eircom.net)**

## 1.0 INTRODUCTION

St. Fintan's is a small Church located on an elevated site within a graveyard on Carrickbrack Road, Sutton. The date of origin is not known but it is described as appearing to be pre or early Norman with later additions.

St. Fintan's Church was visited on the 14<sup>th</sup> November 2011. The weather was cloudy and rainy.



West elevation

## 2.0 DESCRIPTION

The dimensions of the church are small (6.5 x 3.8). The walls are 750mm thick with a slight batter. It is formed from granite, sandstone and tufa rock with rubble stones of varying sizes and is uncoursed. The west wall carries a simple bell-cote. There is a rectangular window above the door with a smaller opening just below. The present pointed arch entrance doorway is very narrow (ca 600mm) and quite low and appears to have been inserted. A possible lintel stone above the door provides some evidence that the original door may have been higher and wider.

The east wall had a sept-foil tracery sandstone window which is roughly blocked up. In contrast to the entrance door, the east window is proportionally quite large for the size of the building.



There is a small recess on the exterior to the right of the east window, the purpose of which is unclear.



East elevation

There is a small square headed window with splayed reveals at the east end of the south wall and there are two niches on this wall, one with chamfered sides which may have been a window and one with a square head near the west end. On the north wall there is a square headed window near the west end and a round-headed window at the east end. There is also a niche in this wall. Some historic plaster remains on the interior walls.



South elevation

The tops of the north and south walls have been repaired in the past and capped with cement mortar, the new construction being separated from the old by a dpc (damp proof course). The west wall and bell-cote have been re-pointed in cement mortar. The interior of the building is overgrown and ivy is growing on the east face of the bell-cote and over the north and south walls. The building has been secured by a locked steel gate and a steel caging over the interior.



North elevation

A fenced grave plot belonging to the Bellingham family occupies the full length of the north wall.

### 3.0 CONDITION

The various repairs carried out have helped to stabilize the structure but there are a number of defects which require to be addressed:

- a) The interior is overgrown and the vegetation is beginning to cause damage to the masonry.
- b) There is some evidence of subsidence along the north wall which may be associated with the graves in the Bellingham family plot. The subsidence may be historic, as no burials have been carried out in the recent past.





Remnant of tracery on east window

- c) Much of the mortar appears to have been washed out of the south, north and east walls. (This applies to the exterior. The pointing on the wall interiors appears to be in quite good condition).
- d) The cement pointing of the west wall is inappropriate and may eventually cause damage to the fabric.
- e) The infill in the east window appears to be unstable.

#### **4.0 VULNERABILITY**

The works carried out in the past, while not all appropriate have helped to prevent deterioration of the structure. In due course the cement pointing on the west wall will cause problems but this is not an immediate concern. If the blocking up of the east window is not repaired access to the interior may become possible and this could lead to vandalism.

On a scale of vulnerability of 1 to 5 the monument may be considered to be at level 2. The most pressing matter is the possible collapse of the infill on the east window.



Interior looking towards the entrance (west)



Interior showing the east wall

## 5.0 RECOMMENDED WORKS

The monument is generally in reasonable condition and is well protected from vandalism although the heavy steel caging is visually unattractive. The proposed works are largely maintenance in character as the building is not under immediate threat.

Ministerial consent would be required for all the works proposed except for removal of vegetation.

- 5.1 The building should be sprayed with biocide and the vegetation removed. After spraying the vegetation should be carefully cut away. Vegetation should never be pulled from historic masonry as damage to mortar and stones could ensue.
- 5.2 The apparent cracking in the north wall should be monitored by inspection and photography at regular intervals. Should it get worse, it may be necessary to take action which might involve underpinning or provision of drainage in the vicinity of the wall. Any excavation would have to be monitored by a licenced archaeologist.
- 5.3 The exteriors of the north, south and east walls should be entirely re-pointed. The pointing should be a mix of lime putty and sand. Samples of the original mortar should be tested and the repair mortar should match as far as possible the original.
- 5.4 Consideration should be given to removing the cement pointing from the west wall and replacing it with lime mortar. However it is possible that attempting to remove the cement would do more harm than good and a test on a small area should be carried out prior to embarking on a full scale removal.
- 5.5 The infill in the east window appears to be quite old and lime mortar was used. It would therefore be inappropriate to remove the infill completely and to replace it. It should be repaired to ensure the security of the building.
- 5.6 Generally all reasonable measures should be taken to try to prevent digging of graves directly against the walls of the structure.

- 5.7 An information sign should be erected at the site to inform the public of the significance of the monument.

---

DERMOT NOLAN BA BAI Eur Ing CEng MIEI

**CHARTERED ENGINEER AND  
HISTORIC BUILDINGS CONSULTANT**



## **APPENDIX**

### **DRAWINGS AND SITE LOCATION**

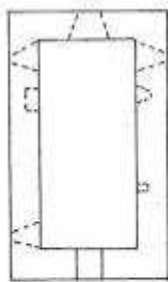

PLAN



SOUTH ELEVATION

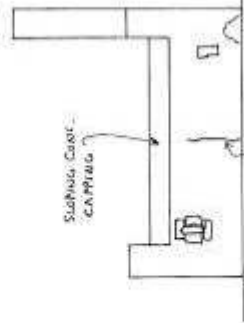

NORTH ELEVATION

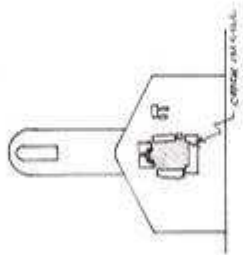

EAST ELEVATION

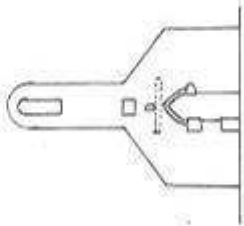

WEST ELEVATION



NORTH WALL (INTERIOR)



SOUTH WALL (INTERIOR)

- Note:
1. ACCESS TO THE INTERIOR IS PRESENTED BY STEEL CORNERS AND A STEEL DOOR (NOT SHOWN).
  2. THE INTERIOR IS ENTIRELY UNDEVELOPED.
  3. THE EAST SIDE OF THE BELLTOWER IS COVERED IN ART.

SAINT FABIAN'S CHURCH CARLSBERG

SCALE: 1/4"=1'-0"

NOVEMBER 2011

Dermot Nolan & Associates  
 Miami Building Consultant and Consulting Engineer

DERMOT NOLAN  
 D.A.B.01 For the City 3883

"Charlotte", North Road, Bury, Ch. Wiltshire  
 Wiltshire, UK. Tel: 01753 253111 - Mobile: 081-2431859  
 Email: d.nolan@dermotnolan.com | dnm@dermotnolan.com



**Comhairle Contae Fhine Gall**  
Fingal County Council

**Record of Protected Structures**



RPS No. 575 St, Fintan's Church (in ruins), Carrickbrack Road, Sutton, Co. Dublin



Scale 1:1000



